

REFRIGERANT  
R32/R410A

## CEILING CASSETTE TYPE AIR CONDITIONERS

MLZ-KP25VF MLZ-KP35VF MLZ-KP50VF

### INSTALLATION MANUAL

For INSTALLER

- This manual only describes the installation of indoor unit. When installing the outdoor unit, refer to the installation manual of outdoor unit.

English

**CONTENTS**

1. BEFORE INSTALLATION.....	1	6. PUMPING DOWN .....	10
2. INDOOR UNIT INSTALLATION.....	4	7. CONNECTING AN INTERFACE (OPTION) TO THE AIR CONDITIONER.....	10
3. FLARING WORK AND PIPE CONNECTION .....	7	This installation manual describes only for the indoor unit. Refer to the MXZ type manual for outdoor unit set up.	
4. TEST RUN.....	9		
5. GRILLE (OPTION) INSTALLATION .....	9		





**Required Tools for Installation**

Phillips screwdriver	Flare tool for R32, R410A
Level	Gauge manifold for R32, R410A
Scale	Vacuum pump for R32, R410A
Utility knife or scissors	Charge hose for R32, R410A
75 mm hole saw	Pipe cutter with reamer
Torque wrench	Water bottle
Wrench (or spanner)	0.9 to 1.0 L water

Appropriate personal protective equipment  
The installer should ensure they check the respective Work Health and Safety (WHS) Act within their jurisdiction as the requirements and obligations may differ.

**1. BEFORE INSTALLATION**

**MEANINGS OF SYMBOLS DISPLAYED ON INDOOR UNIT AND/OR OUTDOOR UNIT**

	<b>WARNING</b> (Risk of fire)	This unit uses a flammable refrigerant. If refrigerant leaks and comes in contact with fire or heating part, it will create harmful gas and there is risk of fire.
		Read the OPERATING INSTRUCTIONS carefully before operation.
		Service personnel are required to carefully read the OPERATING INSTRUCTIONS and INSTALLATION MANUAL before operation.
		Further information is available in the OPERATING INSTRUCTIONS, INSTALLATION MANUAL, and the like.

**1-1. THE FOLLOWING SHOULD ALWAYS BE OBSERVED FOR SAFETY**

- Be sure to read "THE FOLLOWING SHOULD ALWAYS BE OBSERVED FOR SAFETY" before installing the air conditioner.
- Be sure to observe the warnings and cautions specified here as they include important items related to safety.
- After reading this manual, be sure to keep it together with the OPERATING INSTRUCTIONS for future reference.

**WARNING** (Could lead to death, serious injury, etc.)

- **Do not install the unit by yourself (user).**  
Incomplete installation could cause fire or electric shock, injury due to the unit falling, or leakage of water. Consult the dealer from whom you purchased the unit or a qualified installer.
- **Perform the installation securely referring to the installation manual.**  
Incomplete installation could cause fire or electric shock, injury due to the unit falling, or leakage of water.
- **When installing the unit, use appropriate protective equipment and tools for safety.**  
Failure to do so could cause injury.
- **Install the unit securely in a place which can bear the weight of the unit.**  
If the installation location cannot bear the weight of the unit, the unit could fall causing injury.
- **Electrical work should be performed by a qualified, experienced electrician, according to the installation manual. Be sure to use an exclusive circuit. Do not connect other electrical appliances to the circuit.**  
If the capacity of the power circuit is insufficient or there is incomplete electrical work, it could result in a fire or an electric shock.
- **Earth the unit correctly.**  
Do not connect the earth to a gas pipe, water pipe, lightning rod or telephone earth. Defective earthing could cause electric shock.
- **Do not damage the wires by applying excessive pressure with parts or screws.**  
Damaged wires could cause fire or electric shock.
- **Be sure to cut off the main power in case of setting up the indoor P.C. board or wiring works.**  
Failure to do so could cause electric shock.
- **Use the specified wires to connect the indoor and outdoor units securely and attach the wires firmly to the terminal block connecting sections so the stress of the wires is not applied to the sections. Do not extend the wires, or use intermediate connection.**  
Incomplete connecting and securing could cause fire.
- **Do not install the unit in a place where inflammable gas may leak.**  
If gas leaks and accumulates in the area around the unit, it could cause an explosion.
- **Do not use intermediate connection of the power cord or the extension cord and do not connect many devices to one AC outlet.**  
It could cause a fire or an electric shock due to defective contact, defective insulation, exceeding the permissible current, etc.
- **Be sure to use the parts provided or specified parts for the installation work.**  
The use of defective parts could cause an injury or leakage of water due to a fire, an electric shock, the unit falling, etc.
- **When plugging the power supply plug into the outlet, make sure that there is no dust, clogging, or loose parts in both the outlet and the plug. Make sure that the power supply plug is pushed completely into the outlet.**  
If there is dust, clogging, or loose parts on the power supply plug or the outlet, it could cause electric shock or fire. If loose parts are found on the power supply plug, replace it.
- **Attach the electrical cover to the indoor unit and the service panel to the outdoor unit securely.**  
If the electrical cover of the indoor unit and/or the service panel of the outdoor unit are not attached securely, it could result in a fire or an electric shock due to dust, water, etc.
- **When installing, relocating, or servicing the unit, make sure that no substance other than the specified refrigerant (R32/R410A) enters the refrigerant circuit.**  
Any presence of foreign substance such as air can cause abnormal pressure rise and may result in explosion or injury. The use of any refrigerant other than that specified for the system will cause mechanical failure, system malfunction, or unit breakdown. In the worst case, this could lead to a serious impediment to securing product safety.
- **Do not discharge the refrigerant into the atmosphere. If refrigerant leaks during installation, ventilate the room. Check that the refrigerant does not leak after installation has been completed.**  
If refrigerant leaks and comes in contact with fire or heating part of such a fan heater, kerosene heater, or cooking stove, it will create harmful gas.
- **Use appropriate tools and piping materials for installation.**  
The pressure of R32/R410A is 1.6 times more than R22. Not using appropriate tools or materials and incomplete installation could cause the pipes to burst or injury.
- **When pumping down the refrigerant, stop the compressor before disconnecting the refrigerant pipes.**  
If the refrigerant pipes are disconnected while the compressor is running and the stop valve is open, air could be drawn in and the pressure in the refrigeration cycle could become abnormally high. This could cause the pipes to burst or injury.
- **When installing the unit, securely connect the refrigerant pipes before starting the compressor.**  
If the compressor is started before the refrigerant pipes are connected and when the stop valve is open, air could be drawn in and the pressure in the refrigeration cycle could become abnormally high. This could cause the pipes to burst or injury.
- **Fasten a flare nut with a torque wrench as specified in this manual.**  
If fastened too tight, a flare nut may break after a long period and cause refrigerant leakage.
- **The unit shall be installed in accordance with national wiring regulations.**
- **When using a gas burner or other flame-producing equipment, completely remove all of the refrigerant from the air conditioner and ensure that the area is well-ventilated.**  
If the refrigerant leaks and comes in contact in fire or heating part, it will create harmful gas and there is risk of fire.
- **Do not use means to accelerate the defrosting process or to clean, other than those recommended by the manufacturer.**
- **The appliance shall be stored in a room without continuously operating ignition sources (for example: open flames, an operating gas appliance or an operating electric heater).**
- **Do not pierce or burn.**
- **Be aware that refrigerants may not contain an odour.**
- **Pipe-work shall be protected from physical damage.**
- **The installation of pipe-work shall be kept to a minimum.**
- **Compliance with national gas regulations shall be observed.**
- **Keep any required ventilation openings clear of obstruction.**
- **Keep gas-burning appliances, electric heaters, and other fire sources (ignition sources) away from the location where installation, repair, and other air conditioner work will be performed.**
- **The appliance shall be stored in a well-ventilated area where the room size corresponds to the room area as specified for operation.**
- **In Australia, only technicians that possess the appropriate license issued by the Australian Refrigeration Council (ARC) should install this product.**

**⚠ CAUTION** (Could lead to serious injury in particular environments when operated incorrectly.)

- **Install an earth leakage breaker depending on the installation place.**  
If an earth leakage breaker is not installed, it could cause electric shock.
- **Perform the drainage/piping work securely according to the installation manual.**  
If there is defect in the drainage/piping work, water could drop from the unit, soaking and damaging household goods.
- **Do not touch the air inlet or the aluminum fins of the outdoor unit.**  
This could cause injury.
- **Do not install the outdoor unit where small animals may live.**  
If small animals enter and touch the electric parts inside the unit, it could cause a malfunction, smoke emission, or fire. Also, advise user to keep the area around the unit clean.
- **Do not operate the air conditioner during interior construction and finishing work, or while waxing the floor.**  
Before operating the air conditioner, ventilate the room well after such work is performed. Otherwise, it may cause volatile elements to adhere inside the air conditioner, resulting in water leakage or scattering of dew.

## 1-2. SELECTING THE INSTALLATION LOCATION

### INDOOR UNIT

**⚠ ⚠ WARNING**

**This unit should be installed in rooms which exceed the floor space specified in outdoor unit installation manual.**

- Refer to outdoor unit installation manual.

- Where airflow is not blocked.
- Where cool (or warm) air spreads over the entire room.
- Where it is not exposed to direct sunshine. Do not expose to direct sunshine also during the period following unpacking to before use.
- Where easily drained.
- At a distance 1 m or more away from your TV and radio. Operation of the air conditioner may interfere with radio or TV reception. An amplifier may be required for the affected device.
- In a place as far away as possible from fluorescent and incandescent lights. In order to make the infrared remote control operate the air conditioner normally. The heat from the lights may cause deformation or the ultraviolet may cause deterioration.
- Where the air filter can be removed and replaced easily.
- Where it is away from the other heat or steam source.

### REMOTE CONTROLLER

- Where it is easy to operate and easily visible.
- Where children cannot touch it.
- Select a position about 1.2 m above the floor and check that signals from the remote controller are surely received by the indoor unit from that position ('beep' or 'beep beep' receiving tone sounds). After that, attach remote controller holder to a pillar or wall and install wireless remote controller.

**Note:**

In rooms where inverter type fluorescent lamps are used, the signal from the wireless remote controller may not be received.

**Note:**

Avoid the following places for installation where air conditioner trouble is liable to occur.

- Where flammable gas could leak.
- Where there is much machine oil.
- Where oil is splashed or where the area is filled with oily smoke (such as cooking areas and factories, in which the properties of plastic could be changed and damaged).
- Salty places such as the seaside.
- Where sulfide gas is generated such as hot spring, sewage, waste water.
- Where there is high-frequency or wireless equipment.
- Where there is emission of high levels of VOCs, including phthalate compounds, formaldehyde, etc., which may cause chemical cracking.
- The appliance shall be stored so as to prevent mechanical damage from occurring.

## 1-3. SPECIFICATIONS

Model	Power supply *1		Wire specifications *2	Pipe size (thickness *3, *4, *5, *6)		Insulation thickness *7, *8
	Rated Voltage	Frequency	Indoor/outdoor connecting wire	Gas	Liquid	
MLZ-KP25/35VF	230 V	50 Hz	4-core 1.5 mm <sup>2</sup>	ø9.52 mm (0.8 mm)	ø6.35 mm (0.8 mm)	14 mm
MLZ-KP50VF				ø12.7 mm (0.8 mm)		

\*1 Connect to the power switch which has a gap of 3 mm or more when open to interrupt the source power phase. (When the power switch is shut off, it must interrupt all phases.)

\*2 Use wires in conformity with design 60245 IEC 57.

\*3 Never use pipes with thickness less than specified. The pressure resistance will be insufficient.

\*4 Use a copper pipe or a copper-alloy seamless pipe.

\*5 Be careful not to crush or bend the pipe during pipe bending.

\*6 Refrigerant pipe bending radius must be 100 mm or more.

\*7 Insulation material : Heat resisting foam plastic 0.045 specific gravity

\*8 Be sure to use the insulation of specified thickness. Excessive thickness may cause incorrect installation of the indoor unit and insufficient thickness may cause dew drippage.

## 1-4. INSTALLATION DIAGRAM

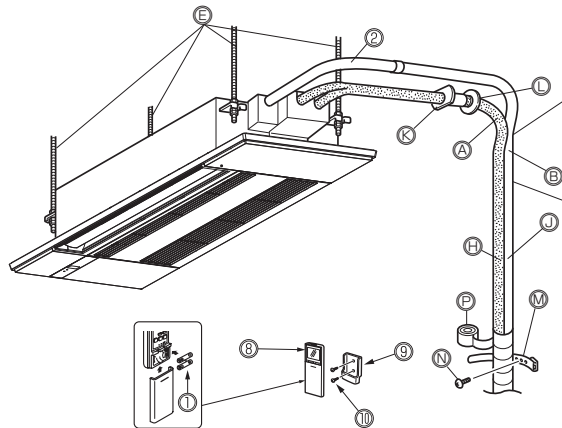

Units should be installed by licensed contractor according to local code requirements.

### IMPORTANT NOTES

- To comply with the requirements of Australian standard AS/NZS 3000 electrical installations (wiring rules), the electrical wiring required between the indoor and outdoor units must be installed by a licenced electrical contractor.
- Check that cabling will not be subject to wear, corrosion, excessive pressure, vibration, sharp edges or any other adverse environmental effects. The check shall also take into account the effects of aging or continual vibration from sources such as compressors or fans.

Be sure to use wall hole sleeve (K) to prevent indoor/outdoor connecting wire (D) from contacting metal parts in the wall and to prevent damage by rodents in case the wall is hollow.

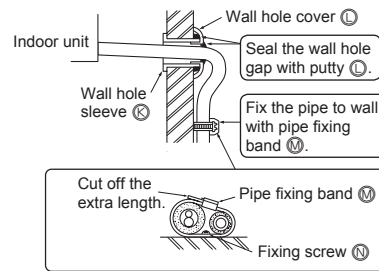

After the leak test, apply insulating material tightly so that there is no gap.

When the piping is to be attached to a wall containing metals (tin plated) or metal netting, use a chemically treated wooden piece 20 mm or thicker between the wall and the piping or wrap 7 to 8 turns of insulation vinyl tape around the piping.  
To use existing piping, perform COOL operation for 30 minutes and pump down before removing the old air conditioner. Remake flare according to the dimension for new refrigerant.

### ⚠️ ⚠️ WARNING

To avoid risk of fire, embed or protect the refrigerant piping.  
External damage on the refrigerant piping can be cause of fire.

### Service space

- The dimensions of ceiling opening can be regulated within the range shown in following diagram; so center the main unit against the opening of ceiling, ensuring that the respective opposite sides on all sides of the clearance between them becomes identical.

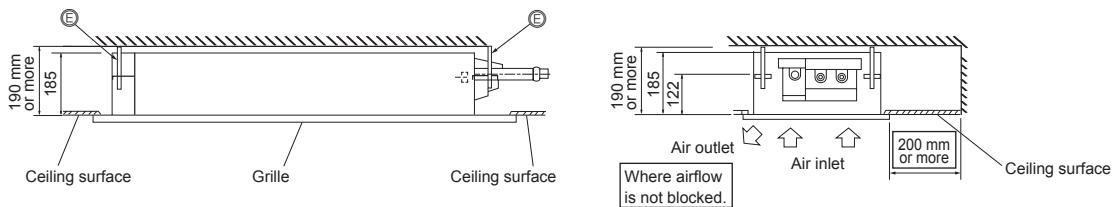

### ACCESSORIES

Check the following parts before installation.

①	Alkaline battery (AAA) for ⑧	2
②	Drain hose (with insulation)	1
③	Special washer (with cushion, 4 pcs)	8
④	Installation template	1
⑤	Fixing screw for ④ M5 × 30 mm	4
⑥	Band	1
⑦	Fixing screw for ⑥ 4 × 16 mm	2
⑧	Remote controller	1
⑨	Remote controller holder	1
⑩	Fixing screw for ⑨ 3.5 × 16 mm (Black)	2

### PARTS TO BE PROVIDED AT YOUR SITE

Ⓐ	Refrigerant pipe	1
Ⓑ	Drain pipe (O.D. 26)	1
Ⓒ	Installation tools (See 1-3)	1
Ⓓ	Indoor/outdoor unit connecting wire*	1
Ⓔ	Suspension bolt (M10)	4
Ⓕ	Nut with flange (M10)	8
Ⓖ	Nut (M10)	4
Ⓗ	Insulating material for Ⓐ (Heat resistant foamed polyethylene, specific gravity 0.045, thickness more than 14 mm)	1
Ⓙ	Insulating material for Ⓑ (Foamed polyethylene, specific gravity 0.03, thickness more than 10 mm)	1

Ⓚ	Wall hole sleeve	1
Ⓛ	Parts for mending wall hole (putty, cover)	1
Ⓜ	Pipe fixing band	2 to 7
Ⓝ	Fixing screw for Ⓜ	2 to 7
Ⓟ	Piping tape	1 to 5

#### \* Note:

Place indoor/outdoor unit connecting wire (D) at least 1 m away from the TV antenna wire.



### Unit suspension procedures

- Adjust the length of the bolt's protrusion from the ceiling surface beforehand.
  - Check the pitch of the suspension bolt ⑤. (308 mm × 1051 mm)
- Install special washer ③ and their nuts ⑥ onto the suspension bolt ⑤ in advance.
    - Do this in the following order (from the top): nut ⑥, special washer with cushion ③, special washer ③, nut ⑥, nut ⑥.
    - Position special washer, with cushion ③ with the insulated surface pointing down, as in the figure.
  - Lift the unit into place, aligned properly with suspension bolt ⑤. Pass the bracket between special washer, with cushion ③ and special washer ③, which are already in place, and secure it. Do the same in all four places.
    - Make sure the suspension bolt ⑤ extends 70 mm or more from the surface of the ceiling. Otherwise you will not be able to install the grille (optional).
    - If the points for securing the grille are not flush with the ceiling surface, water may condense, or the panel may not open/close.**
  - If the long opening in the bracket and opening in the ceiling do not align, adjust them until they do.
  - Check that the four places for securing the grille are all level using a spirit level.
  - Tighten all the nuts.

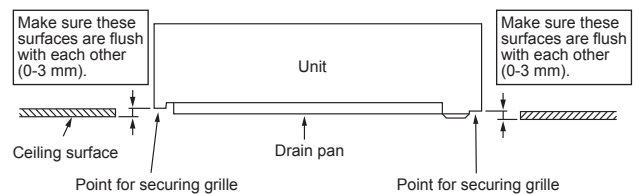
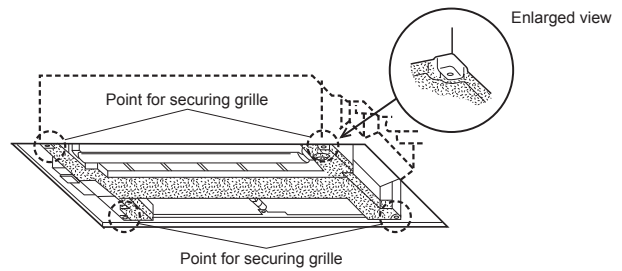
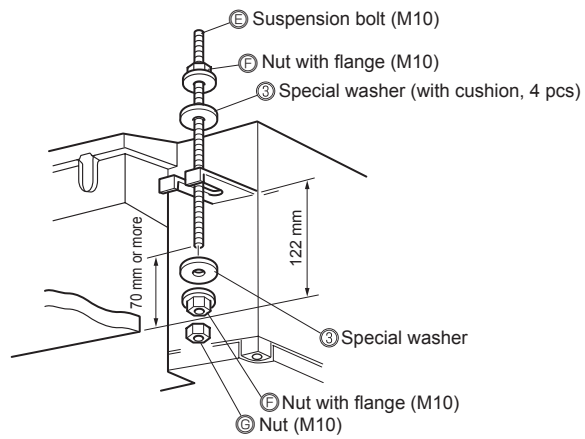
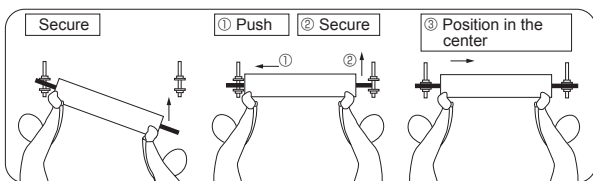

## 2-2. HOLE DRILLING

- Determine the wall hole position.
- Drill a dia. 75 mm hole. The outdoor side should be 5 to 7 mm lower than the indoor side.
- Insert wall hole sleeve ㉞.

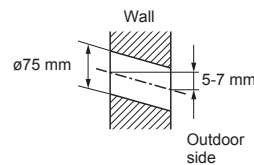

## 2-3. DRAIN PIPING

- Use drain pipe ㉞ for drain piping. Be sure to connect the piping joints using adhesive of polyvinyl chloride family to prevent leakage.
- Before drain piping work, remove the pipe cover, hose band, pipe band, and spacer (cushion). Dispose of the spacer (cushion), as it will not be needed.
- Drain hose ㉞ is 550 mm long, so that drain piping exit can be moved up. Cut drain hose ㉞ into appropriate length before connecting.

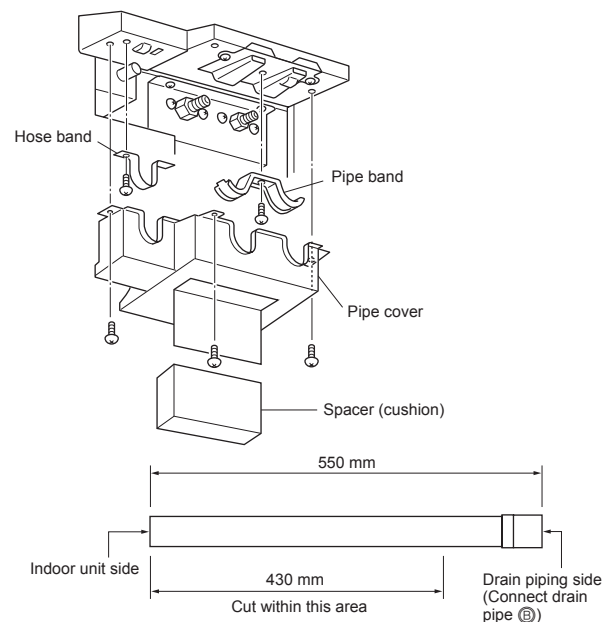

- Connect drain pipe ③ directly to drain piping connecting part (socket side) of drain hose ②.
- Be sure to connect drain hose ② to the indoor unit side as shown in the illustration on the right. Be sure to connect the drain hose connecting part using adhesive of polyvinyl chloride family to prevent leakage.
- To bring up the drain exit, first arrange drain hose ② to go upward vertically, and then provide 1/100 or more downward slope, as shown in the illustration below.

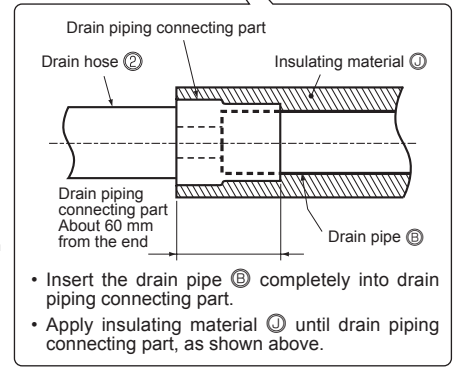
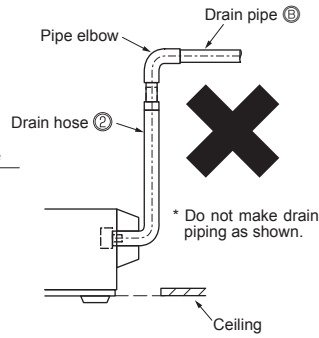
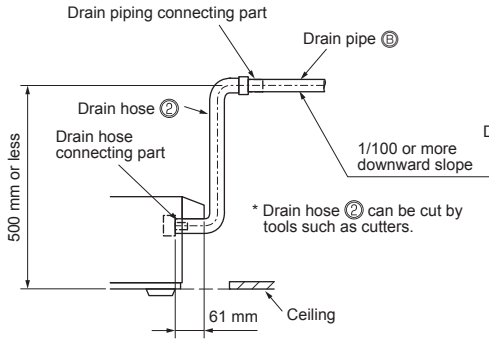
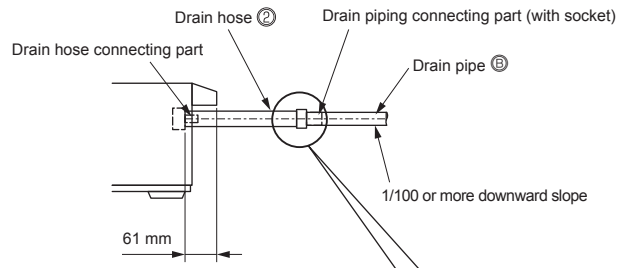

- If the drain piping pass indoor, be sure to apply insulating material ④ (Foamed polyethylene, specific gravity 0.03, thickness more than 10 mm). Connect drain hose connecting part using adhesive of polyvinyl chloride family before installing the hose band.

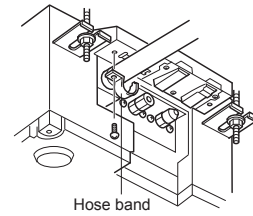

- Apply insulating material ④ until drain piping connecting part, as shown in the upper right illustration.
- Drain piping should form a downward slope (1/100 or more) to the outdoor drain exit. Do not form trap or raise the pipe.
- Do not arrange the pipe horizontally for more than 20 m. When the drain piping is too long, use support metal to prevent the drain pipe from forming an up or down curve. Be sure not to install an air bleeder. (Since drain lift-up mechanism is built-in, drain may blow out.)
- Odor trap for drain outlet is not necessary.
- For grouped piping, arrange piping so that the grouped piping is about 100 mm lower than the unit drain exit, as shown in the figure. Use about a drain pipe (O.D. 38 mm) for grouped piping, and arrange it so that it forms about 1/100 or more downward slope.
- Do not place drain piping directly into a place where ammonia gas or sulfuric gas is formed, such as sewage tanks or septic tanks.

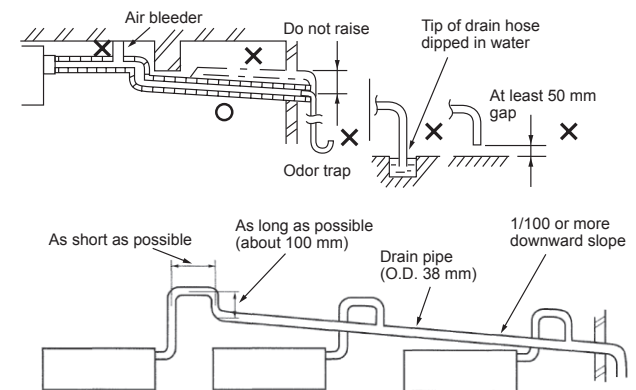
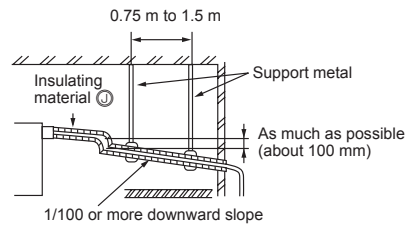

## 2-4. CONNECTING WIRES FOR INDOOR UNIT

- 1) Remove electrical cover (1).
- 2) Remove cord clamp.
- 3) Pass indoor/outdoor unit connecting wire ② process the end of the wire.
- 4) Loosen terminal screw, and connect first the earth wire, then indoor/outdoor unit connecting wire ② to the terminal block. Be careful not to make mis-wiring. Fix the wire to the terminal block securely so that no part of its core is appeared, and no external force is conveyed to the connecting section of the terminal block.
- 5) Firmly tighten the terminal screws to prevent them from loosening. After tightening, pull the wires lightly to confirm that they do not move.
- 6) Secure indoor/outdoor unit connecting wire ② and the earth wire with the cord clamp. Never fail to hook the left claw of the cord clamp. Attach the cord clamp securely.

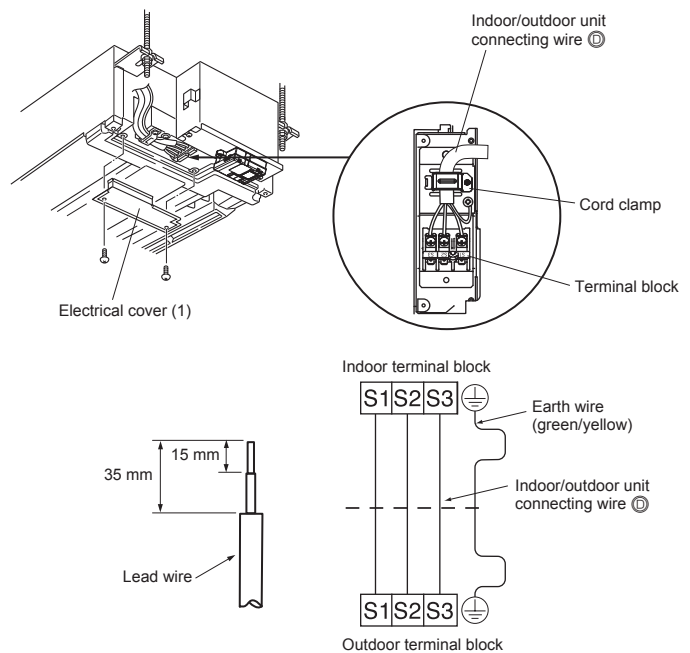

- Make earth wire a little longer than others. (More than 55 mm)
- For future servicing, give extra length to the connecting wires.

### When the ceiling is above 2.4 m and 2.7 m or below

Move the slide switch (SW3) to the right to increase airflow volume.

\* When the ceiling is above 2.7 m, airflow volume may be insufficient even with the slide switch (SW3) set to "increase airflow".

- 1) Make sure that the breaker for air conditioner is turned OFF.
- 2) Remove electrical cover (1) and (2) of the indoor unit.
- 3) Slide out the electronic control P.C. board, and switch up the slide switch (SW).
- 4) Put the electronic control P.C. board back to the original position, and install electrical cover (1) and (2).

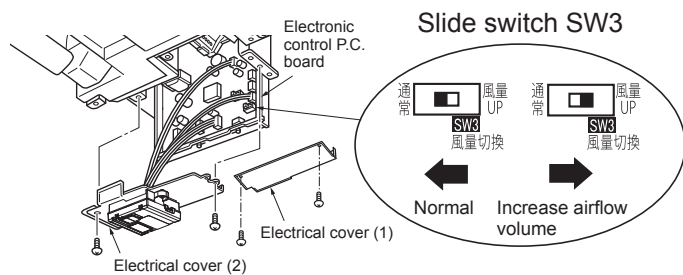

### Note:

- Perform static elimination before setting.
- Default setting is Normal.

## 3. FLARING WORK AND PIPE CONNECTION

### 3-1. PIPING WORK

- 1) Remove the pipe cover, hose band, pipe band, and spacer (cushion) of the indoor unit. Dispose of the spacer (cushion), as it will not be needed.
- 2) When using pipe with super insulating material (about  $\phi 48$  mm liquid pipe,  $\phi 51$  mm gas pipe) for indoor connecting pipe, remove plate and turn it over so that the concave part faces upward.

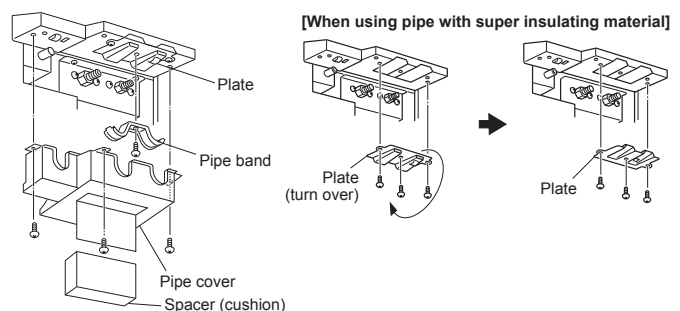



### 3-2. FLARING WORK

- 1) Cut the copper pipe correctly with pipe cutter. (Fig. 1, 2)
- 2) Completely remove all burrs from the cut cross section of pipe. (Fig. 3)
  - Put the end of the copper pipe to downward direction as you remove burrs in order to avoid to let burrs drop in the piping.
- 3) Remove flare nuts attached to indoor and outdoor units, then put them on pipe having completed burr removal. (Not possible to put them on after flaring work.)
- 4) Flaring work (Fig. 4, 5). Firmly hold copper pipe in the dimension shown in the table. Select A mm from the table according to the tool you use.
- 5) Check
  - Compare the flared work with Fig. 6.
  - If flare is noted to be defective, cut off the flared section and do flaring work again.

Pipe diameter (mm)	Nut (mm)	A (mm)			Tightening torque	
		Clutch type tool for R32, R410A	Clutch type tool for R22	Wing nut type tool for R22	N•m	kgf•cm
ø6.35 (1/4")	17	0 to 0.5	1.0 to 1.5	1.5 to 2.0	13.7 to 17.7	140 to 180
ø9.52 (3/8")	22			34.3 to 41.2	350 to 420	
ø12.7 (1/2")	26			2.0 to 2.5	49.0 to 56.4	500 to 575
ø15.88 (5/8")	29			-	73.5 to 78.4	750 to 800

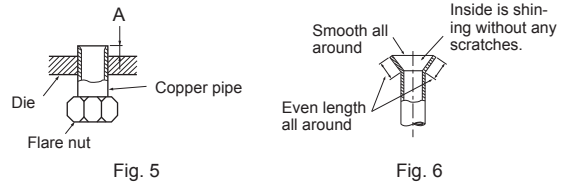
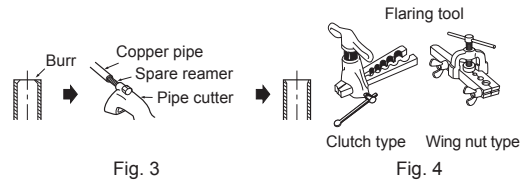
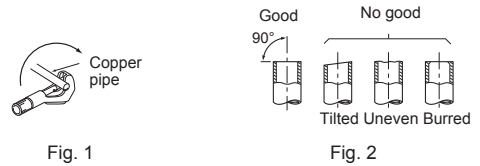

### 3-3. PIPE CONNECTION

- In case of reconnecting the refrigerant pipes after detaching, make the flared part of pipe re-fabricated.
- Fasten flare nut with a torque wrench as specified in the table.
- When fastened too tight, flare nut may brake after a long period and cause refrigerant leakage.
- Be sure to wrap insulation around the piping. Direct contact with the bare piping may result in burns or frostbite.

#### Indoor unit connection

Connect both liquid and gas pipings to indoor unit.

- Apply a thin coat of refrigeration oil on the seat surface of pipe.
- For connection, first align the center, then tighten the first 3 to 4 turns of flare nut.
- Use tightening torque table above as a guideline for indoor unit side union joint section, and tighten using two wrenches. Excessive tightening damages the flare section.

#### Outdoor unit connection

Connect pipes to stop valve pipe joint of the outdoor unit in the same manner applied for indoor unit.

- For tightening, use a torque wrench or spanner and use the same tightening torque applied for indoor unit.

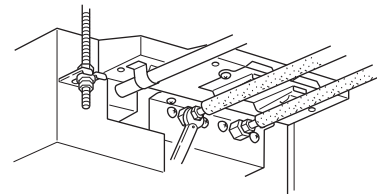

**⚠ WARNING**  
When installing the unit, securely connect the refrigerant pipes before starting the compressor.

**⚠ WARNING**  
Reusable mechanical connectors and flared joints are not allowed indoors.  
When connecting the refrigerant piping by brazing, rather than using flare connections, complete all brazing prior to connecting indoor unit to outdoor unit.

### 3-4. INSTALLING THE PIPE COVER

Make sure to install the pipe cover. Incorrect installation results in water leakage.

- No insulation is needed on the pipe connecting part of the indoor side for this unit. The pipe cover gathers the water condensed around the pipe connecting part.
- 1) Install the pipe band removed in 3-1. to secure the connecting pipes.
    - \* The pipe band should hold down the insulating material of connecting pipe. Insulating material should protrude 10 mm or more than the pipe band, as shown in the illustration on the right.
  - 2) Install pipe cover.

#### When using pipe with super insulating material (about ø48 mm liquid pipe, ø51 mm gas pipe)

- 1) Make sure that the plate is turned over, and the concave part is facing upward. (Refer to 3-1.)
- 2) Use band ⑥ provided with the unit. (Do not use the pipe band attached to the unit)
- 3) Connecting pipe exit of pipe cover is pre-cut. Cut it along the line.
- 4) Install pipe cover.

#### Note:

Install pipe cover and pipe band securely. Incomplete installation will cause water to drip from the unit, soaking and damaging household goods.

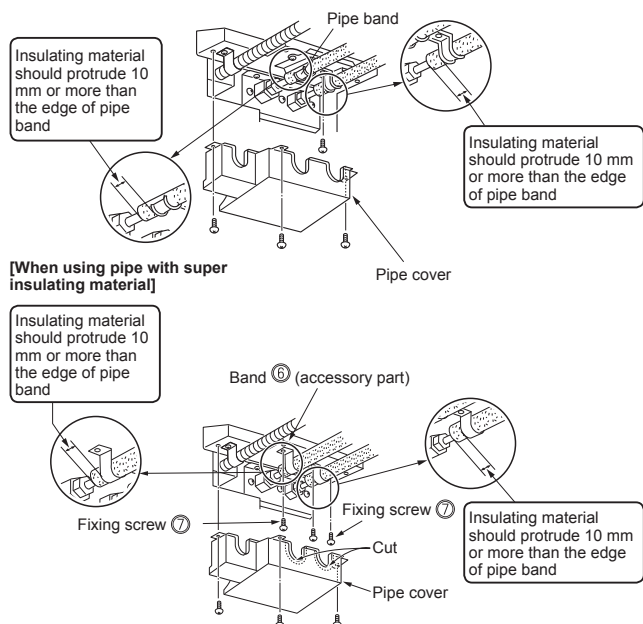

## 4. TEST RUN

### 4-1. TEST RUN

- Do not operate the unit for long periods at places such as building under construction. This may cause dust or odor to adhere to the unit.
- Perform test run with the attendance of user, as much as possible.

- 1) Press the E.O. SW once for COOL, and twice for HEAT operation. Test run will be performed for 30 minutes. If the left lamp of the operation indicator blinks every 0.5 seconds, inspect the indoor/outdoor unit connecting wire ⑩ for mis-wiring. After the test run, emergency mode (set temperature 24°C) will start.
- 2) To stop operation, press the E.O. SW several times until all LED lamps turn off. Refer to operating instructions for details.

#### Checking the remote (infrared) signal reception

Press the OFF/ON button on the remote controller ⑧ and check that an electronic sound is heard from the indoor unit. Press the OFF/ON button again to turn the air conditioner off.

- Once the compressor stops, the restart preventive device operates so the compressor will not operate for 3 minutes to protect the air conditioner.

#### Water drainage check

- 1) Fill the drain pan with about 0.9–1.0 liters of water. (Don't pour water directly into the drain pump.)
- 2) Make a test run of the unit (in Cooling mode).
- 3) Check for water drainage at the outlet of the drainage pipe.
- 4) Stop the test run. (Don't forget to turn off the power.)

### 4-2. WATER DRAINAGE CHECK FOR INDOOR UNIT ONLY

If the wiring work has not been completed, connect terminals S1 and S2 on the indoor terminal block to a 230 V single-phase power supply.

- 1) Start the drain pump test run.
  - Press the emergency operation switch for 5 seconds (until a beep is heard) to start the operation of only the drain pump.
  - The two operation monitor lamps start blinking.
- 2) Stop the drain pump test run.
  - Press the emergency operation switch again to stop the operation of the drain pump. Even if you do not stop the drain pump, it will stop automatically after 15 minutes.
  - The operation monitor lamps turn off.

### 4-3. AUTO RESTART FUNCTION

This product is equipped with an auto restart function. When the power supply is stopped during operation, such as during blackouts, the function automatically starts operation in the previous setting once the power supply is resumed. (Refer to the operating instructions for details.)

### 4-4. EXPLANATION TO THE USER

- Using the OPERATING INSTRUCTIONS, explain to the user how to use the air conditioner (how to use the remote controller, how to remove the air filters, how to remove or put the remote controller in the remote controller holder, how to clean, precautions for operation, etc.)
- Recommend the user to read the OPERATING INSTRUCTIONS carefully.

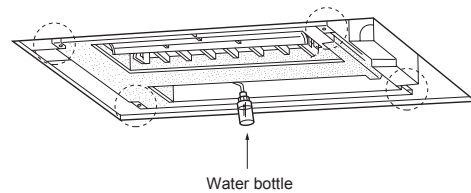
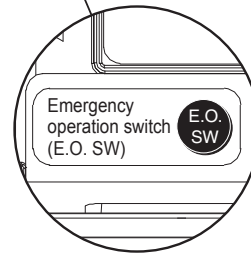
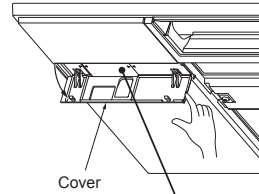
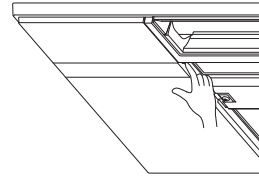

#### Caution:

- After test run or remote signal reception check, turn off the unit with the E.O. SW or the remote controller before turning off the power supply. Not doing so will cause the unit to start operation automatically when power supply is resumed.

#### To the user

- After installing the unit, make sure to explain the user about auto restart function.
- If auto restart function is unnecessary, it can be deactivated. Consult the service representative to deactivate the function. Refer to the service manual for details.

## 5. GRILLE (OPTION) INSTALLATION

Refer to the procedures indicated in the installation manual of the Grille (option).

## 6. PUMPING DOWN

Refer to the procedures indicated in the installation manual of the outdoor unit.

### ⚠ WARNING

When pumping down the refrigerant, stop the compressor before disconnecting the refrigerant pipes. The compressor may burst if air etc. get into it.

## 7. CONNECTING AN INTERFACE (OPTION) TO THE AIR CONDITIONER

- Connect an interface to the indoor control board of an air conditioner with a connecting cable.
- Cutting or extending the connecting cable of the interface results in defects in connecting. Do not bundle the connecting cable together with power supply cord, indoor/outdoor connecting wire, and/or earth wire. Keep as much distance as possible between the connecting cable and those wires.
- The thin part of the connecting cable should be stored and placed where customers cannot touch it.

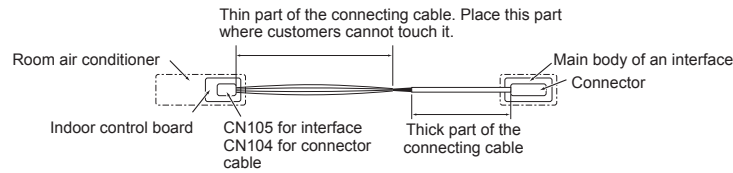

- 1) Fix the cable tie to the connecting cable at 270 mm from the edge of the insulation coating part. Attach the mounting cord clamp (medium) to the interface side of the cable tie.

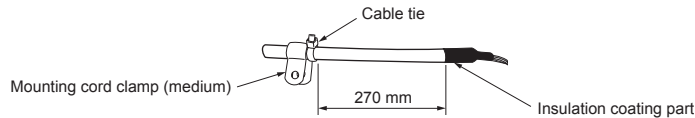

- 2) Remove the grille. (If the grille has been already installed)
- 3) Remove the electrical cover (1), (2).  
Refer to 2-4. CONNECTING WIRES FOR INDOOR UNIT.
- 4) Slide out the indoor control board, and connect the connecting cable to CN105 and/or CN104 on the indoor control board.
- 5) Remove the screw shown in the photo blow. Route the connecting cable according to the photo below. Fix the mounting cord clamp (medium), which has attached to the connecting cable, with the screw.

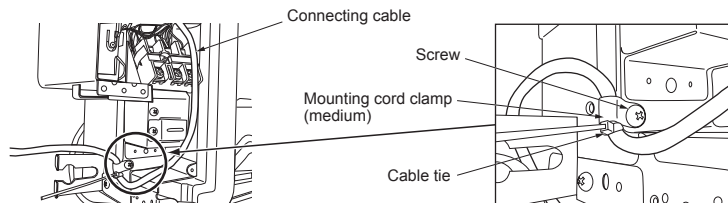

- 6) Reinstall the indoor control board and the electrical cover (1), (2).
- 7) Reinstall the grille.

### ⚠ WARNING

Fix the connecting cable at the prescribed position securely. Incorrect installation may cause electric shock, fire, and/ or malfunction.

This product is designed and intended for use in the residential, commercial and light-industrial environment.

## **MITSUBISHI ELECTRIC CORPORATION**

---

HEAD OFFICE: TOKYO BUILDING, 2-7-3, MARUNOUCHI, CHIYODA-KU, TOKYO 100-8310, JAPAN

RG79Y947H01