



<ORIGINAL>
GB WT08580X01

CITY MULTI Control System
and Mitsubishi Mr. SLIM Air Conditioners

MA Touch Remote Controller

PAR-CT01MAA-PB

PAR-CT01MAA-SB

PAR-CT01MAA-S

PAR-CT01MAR-PB

PAR-CT01MAR-SB

Installation Manual



For distribution to dealers and contractors

- GB
- F
- ES
- I
- PR
- GR
- TR
- SW
- D
- NL
- RU
- CZ
- HG
- PO
- DK

This installation manual describes how to install the MA Touch Remote Controller for use with Mitsubishi Building Air Conditioning System, direct expansion type CITY MULTI air conditioner indoor units (“-A” type and later), and Mitsubishi Mr. SLIM packaged air conditioners.

Please be sure to read this installation manual and the files on the CD-ROM that is supplied with the Touch Remote Controller before proceeding with the installation. Failure to follow the instructions may result in equipment damage.

For information not contained in this booklet, please refer to the files on the CD-ROM that is supplied with the Touch Remote Controller. If the files are not readable, please contact your dealer.

For information on how to wire and install the air conditioning units, refer to the installation manual. After the installation, hand over this manual to users.

1 Safety Precautions

- Thoroughly read the following safety precautions prior to installation.
- Observe these precautions carefully to ensure safety.

WARNING	Indicates a risk of death or serious injury.
CAUTION	Indicates a risk of serious injury or structural damage.

- After reading this manual, pass it on to the end user to retain for future reference.
- Keep this manual for future reference and refer to it as necessary. This manual should be made available to those who repair or relocate the controller. Make sure that the manual is forwarded to future end users.

All electric work must be performed by qualified personnel.

GB

General precautions

WARNING

Do not install the unit in a place where large amounts of oil, steam, organic solvents, or corrosive gases, such as sulfuric gas, are present or where acidic/alkaline solutions or sprays are used frequently. These substances can compromise the performance of the unit or cause certain components of the unit to corrode, which can result in electric shock, malfunctions, smoke, or fire.

To reduce the risk of shorting, current leakage, electric shock, malfunctions, smoke, or fire, do not wash the controller with water or any other liquid.

To reduce the risk of electric shock, malfunctions, smoke or fire, do not operate the switches/buttons or touch other electrical parts with wet hands.

To reduce the risk of injury or electric shock, stop the operation and switch off the power supply before cleaning, maintaining, or inspecting the controller.

To reduce the risk of injury or electric shock, before spraying a chemical around the controller, stop the operation and cover the controller.

To reduce the risk of injury, keep children away while installing, inspecting, or repairing the unit.

Properly install all required covers to keep moisture and dust out of the controller. Dust accumulation and water can cause electric shock, smoke, or fire.

CAUTION

To reduce the risk of electric shock or malfunctions, do not touch the touch panel, switches, or buttons with a pointy or sharp object.

To reduce the risk of damage to the controller, do not directly spray insecticide or other flammable sprays on the controller.

To reduce the risk of injury and electric shock, avoid contact with sharp edges of certain parts.

To reduce the risk of injury, wear protective gear when working on the controller.

Consult your dealer for the proper disposal of the controller.

To avoid injury from broken glass, do not apply excessive force on the glass parts.

To reduce the risk of fire or explosion, do not place flammable materials or use flammable sprays around the controller.

Precautions during installation

WARNING

Do not install the unit where there is a risk of leaking flammable gas. If flammable gas accumulates around the unit, it may ignite and cause a fire or explosion.

Take appropriate safety measures against earthquakes to prevent the controller from causing injury.

Properly dispose of the packing materials. Plastic bags pose suffocation hazard to children.

To prevent injury, install the controller on a flat surface strong enough to support its weight.

CAUTION

To reduce the risk of shorting, current leakage, electric shock, malfunctions, smoke, or fire, do not install the controller in a place exposed to water or in a condensing environment.

Controller must be installed by qualified personnel according to the instructions detailed in the Installation Manual. Improper installation may result in electric shock or fire.

Install the top case into the bottom case until it clicks.

When attaching the cover and the top casing to the bottom casing, push it until it they click into place. If they are not properly locked into place, they may fall, causing personal injury, controller damage, or malfunctions.

Precautions during wiring

WARNING

To reduce the risk of damage to the controller, malfunctions, smoke, or fire, do not connect the power cable to the signal terminal block.

Properly secure the cables in place and provide adequate slack in the cables so as not to stress the terminals. Improperly connected cables may break, overheat, and cause smoke or fire.

To reduce the risk of injury or electric shock, switch off the main power before performing electrical work.

All electric work must be performed by a qualified electrician according to the local regulations, standards, and the instructions detailed in the Installation Manual.

To reduce the risk of electric shock, install a breaker and a residual current circuit breaker on the power supply.
To reduce the risk of electric shock, smoke, or fire, install a breaker for each controller.

Use properly rated breakers and fuses (breaker, local switch <switch + fuse>, no-fuse breaker). Breaker with a breaking capacity greater than the specified capacity may cause electric shock, malfunctions, smoke, or fire.

To reduce the risk of current leakage, overheating, smoke, or fire, use properly rated cables with adequate current carrying capacity.

Proper grounding must be provided by a licensed electrician.
Do not connect the grounding wire to a gas pipe, water pipe, lightning rod, or telephone wire.
Improper grounding may result in electric shock, smoke, fire, or malfunction due to electrical noise interference.

GB

CAUTION

To reduce the risk of electric shock, shorting, or malfunctions, keep wire pieces and sheath shavings out of the terminal block.

To reduce the risk of shorting, current leakage, electric shock, or malfunctions, keep the cables out of contact with controller edges.

Securely seal the cable access holes with putty to prevent condensation, water, and insects from entering and causing electric shock, malfunctions, or fire. Water infiltration and condensation formed inside the unit may damage the circuit board.

Precautions for moving or repairing the controller

WARNING

The controller should be repaired or moved only by qualified personnel.
Do not disassemble or modify the controller.
Improper installation or repair may cause injury, electric shock, or fire.

CAUTION

To reduce the risk of electric shock, shorting, or malfunctions, keep wire pieces and sheath shavings out of the terminal block.

Additional precautions

GB

To avoid damage to the unit, use appropriate tools to install, inspect, or repair the unit.

This controller is designed for exclusive use with the Building Management System by Mitsubishi Electric. The use of this controller for with other systems or for other purposes may cause malfunctions.

To avoid discoloration, do not use benzene, thinner, or chemical rag to clean the controller.
To clean the controller, wipe with a soft cloth soaked in water with mild detergent, wipe off the detergent with a wet cloth, and wipe off water with a dry cloth.

To avoid damage to the controller, provide protection against static electricity.

Take appropriate measures against electrical noise interference when installing the air conditioners in hospitals or facilities with radio communication capabilities.
Inverter, high-frequency medical, or wireless communication equipment as well as power generators may cause the air conditioning system to malfunction. Air conditioning system may also adversely affect the operation of these types of equipment by creating electrical noise.

To avoid malfunctions, do not bundle power cables and signal cables together, or place them in the same metallic conduit.

Leave the circuit board and its protective film on the case.

To avoid damage to the controller, do not overtighten the screws.

Use a flat-head screwdriver with a blade width of 3-5 mm (1/8-7/32 inch).

Do not turn the flat-head screwdriver with fitting it in the latch strongly.

To avoid deformation and malfunction, do not install the remote controller in direct sunlight or where the ambient temperature may exceed 40°C (104°F) or drop below 0°C (32°F).

Do not install the controller on the control panel door. Vibrations or shocks to the controller may damage the controller or cause the controller to fall.

Secure the cable with a clamp.

Do not use solderless terminals to connect cables to the terminal block.
Solderless terminals may come in contact with the circuit board and cause malfunctions or damage the controller cover.

After connecting the connector, install the top case properly.

If the supply cord is damaged, it must be replaced by the manufacturer, its service agent or similarly qualified persons in order to avoid a hazard.

This appliance is not intended for use by persons (including children) with reduced physical, sensory or mental capabilities, or lack of experience and knowledge, unless they have been given supervision or instruction concerning use of the appliance by a person responsible for their safety.
Children should be supervised to ensure that they do not play with the appliance.

This appliance is intended to be used by expert or trained users in shops, in light industry and on farms, or for commercial use by lay persons.

To avoid damage to the controller, use appropriate tools to install, inspect, or repair the controller.

To prevent malfunctions, do not remove the protective film or the circuit board from the casing.

Do not install the controller on the control panel door. Vibrations or shocks to the controller may damage the controller or cause the controller to fall.

To avoid damage to the controller, do not make holes on the controller cover.

Hold the cables in place with clamps to prevent undue force from being applied to the terminal block and causing cable breakage.

2 System Requirements



WARNING

The CD-ROM that is supplied with the unit can only be played on a CD-drive or a DVD-drive. Do not attempt to play this CD-ROM on an audio CD player as this may damage your ears and/or speakers.

Your computer must meet the following requirements to run Manual Navigation Software.

[PC] PC/AT compatible

[CPU] Core2 Duo 1.66 GHz or faster (Core2 Duo 1.86 GHz or faster recommended)

Pentium D 1.7 GHz or faster (Pentium D 3.0 GHz or faster recommended)

Pentium M 1.7 GHz or faster (Pentium M 2.0 GHz or faster recommended)

Pentium 4 2.4 GHz or faster (Pentium 4 2.8 GHz or faster recommended)

* Core2 Duo or faster processor is required to run Manual Navigation Software on Windows Vista or later.

[RAM] Windows Vista or later: 1 GB minimum (2 GB or more recommended)

Windows XP: 512 MB minimum (1 GB or more recommended)

[HDD space] 1 GB minimum (available space)

* Windows Vista or later: Available space in the drive that has the Document folder

* Windows XP: Available space in the drive that has the My Document folder

[Resolution] SVGA 800 × 600 or greater

[OS] Windows8/Pro/Enterprise (Pro recommended)

Windows7 Ultimate/Enterprise/Professional/Home Premium Service Pack1 (Professional recommended)

Windows Vista Ultimate/Business/Home Basic Service Pack1 (Business version recommended)

Windows XP Professional/Home Edition Service Pack2 or Service Pack3 (Professional version recommended)

[Required software] Windows8: Adobe Reader 11.0.2 or later (Windows Reader, installed by default in Windows8, cannot be used.)

Windows7: Adobe Reader 10.1.0 or later

Windows XP and Windows Vista: Adobe Reader 8.1.3 or later

* Software to view PDF files

GB

“Windows”, “Windows XP”, “Windows Vista”, “Windows7” and “Windows8” are registered trade marks of Microsoft Corporation.

“Adobe Reader” and “Adobe Acrobat” are registered trademarks of Adobe Systems Incorporated.

“Core2 Duo” and “Pentium” are registered trademarks of Intel Corporation.

3 Component names and supplied parts

The following parts are included in the box.

Parts name	Qty.	Appearance
Remote controller (top case)	1	Right figure *1
Remote controller (bottom case)	1	Right figure *2
Roundhead cross slot screws M4×30	2	*3
Wood screw 4.1×16 (for direct wall installation)	2	*3
Simple Manual	1	
CD-ROM (this manual) Instruction Book and Installation Manual	1	

Top case *1 Bottom case *2

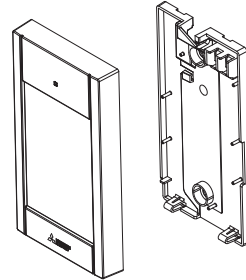

*3 ISO metric screw thread
*4 Remote controller cable is not included.

4 Field-supplied parts/Required tools

(1) Field-supplied parts

The following parts are field-supplied parts.

Parts name	Qty.	Notes
Single switch box	1	Not required for direct wall installation
Thin metal conduit	Necessary	
Lock nut and bushing	Necessary	
Cable cover	Necessary	Required for routing remote controller cable along a wall
Putty	Reasonable	
Molly anchor	Necessary	
Remote controller cable (Use a 0.3 mm ² (AWG22) 2-core sheathed cable.)	Necessary	

Switch box

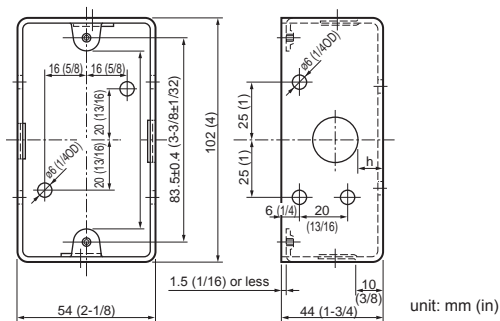

(2) Field-supplied tools

- Flat-tip screwdriver (Width: 3 - 5 mm (1/8 - 7/32 inch))
- Nipper
- Miscellaneous tools

5 How To Wire Transmission Line

The wiring is different when the remote controller is connected to a CITY MULTI control system (“-A” type and later) and when it is connected to a Mr. SLIM air conditioner (A control type). The wiring also differs with the system configuration. Check the system used.

1. Connecting to CITY MULTI control system

The numbers (1) to (4) in the figure correspond to items (1) to (4) in the following description.

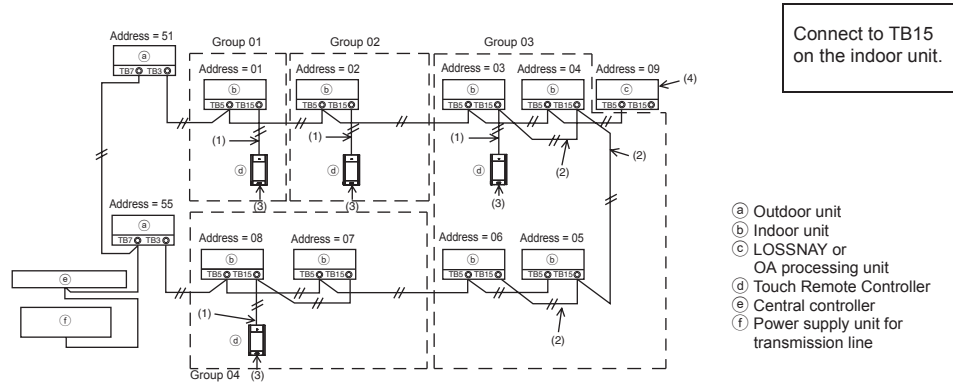

- (1) Wiring from the remote controller
 - Connect to the MA remote controller terminal block (TB15) on the indoor unit.
 - The terminal block has no polarity. Connect to the terminal block at the bottom of the remote controller case.
- (2) Operating in a group (Groups 03, and 04 above)
 - Interconnect the MA remote controller terminal block (TB15) of the indoor units you want to operate as a group, and connect the MA remote controller to that point.
 - When the remote controller is used in combination with the system controller as shown in the figure above, group setting at the system controller (central controller in the figure above) is necessary.
- (3) Number of connectable remote controllers
 - Only one remote controller can be connected to a group made up of indoor units.
 - The MA Touch Remote Controller cannot be used in combination with other MA remote controllers.
- (4) To interlock to a LOSSNAY or OA processing unit, make the following settings using the remote controller. (For a description of how to set an interlock, see section 11 “Service menu” (5) “LOSSNAY setting”.)
 - Set the LOSSNAY or OA processing unit address and the address of all the indoor units you want to interlock.
- (5) Total length of remote controller wiring
 - The MA Touch Remote Controller can be wired up to 70 m (229 ft).

NOTE: When interlocking the MA remote controller with a LOSSNAY or OA processing unit, always set the address of all the indoor units in the group and the address of the LOSSNAY or OA processing unit.

2. Connecting to Mr. SLIM air conditioner

The remote controller wiring depends on the system configuration. Check the system configuration. Wire the remote controller as shown in the example below.

The numbers (1) to (3) in the figure correspond to items (1) to (3) in the following description.

- [1] Connecting the remote controller for each refrigerant system (Standard 1:1, simultaneous twin, simultaneous triple, simultaneous four)

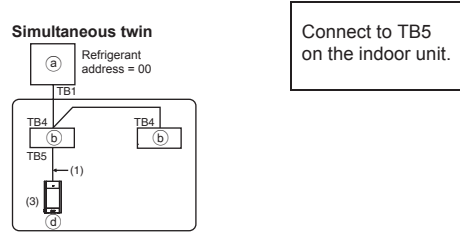

- [2] When grouping by different refrigerant systems

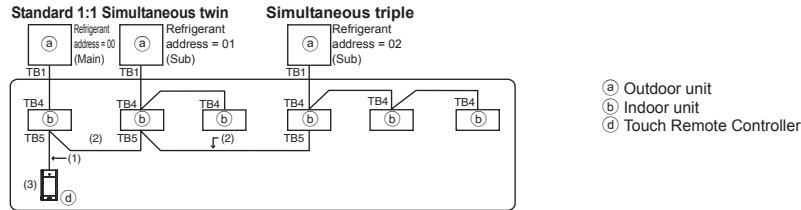

* Set the refrigerant address using the outdoor unit dip switches. (For more information, refer to the outdoor unit installation manual.)

* All the indoor units enclosed in are controlled as one group.

- (1) Wiring from remote controller

- Connect to indoor unit TB5 (remote controller terminal block). (The terminal block has no polarity.)
- For simultaneous multi type, when mixing various types of indoor units, always connect the remote controller to the indoor unit with the most functions (wind velocity, vane, louver, etc.).

- (2) When grouping with difference refrigerant systems

- Group using the remote controller wiring. Connect the remote controller to an arbitrary indoor unit of each refrigerant system you want to group.
- When mixing different types of indoor units in the same group, always make the outdoor unit connecting the indoor unit with the most functions (wind velocity, vane, louver, etc.) the Main unit (refrigerant address = 00). Also, when the Main unit is the simultaneous multi type, always satisfy the conditions of (1) above.
- The MA Touch Remote Controller can control up to 16 refrigerant systems as one group.

- (3) Only one remote controller can be connected to each group. The remote controller cannot be used in combination with other MA remote controllers.

- (4) Total length of remote controller wiring
- The MA Touch Remote Controller can be wired up to 150 m (492 ft).

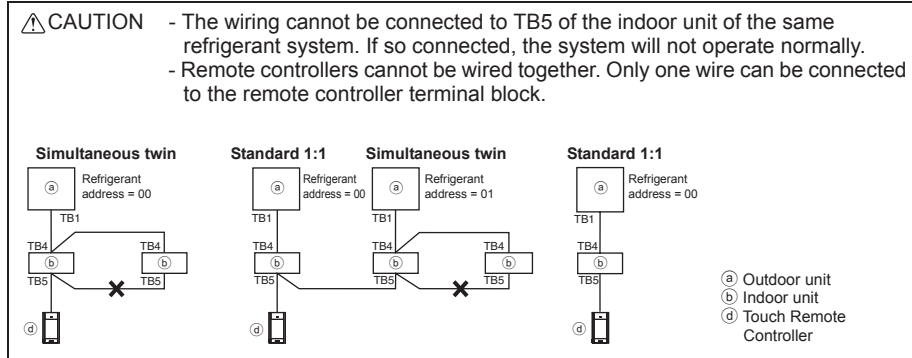

6 How To Install

This remote controller is for the wall installation. It can be installed either in the switch box or directly on the wall. When performing direct wall installation, wires can be thread through either back or top of the remote controller.

(1) Selecting an installation site

Install the remote controller (switch box) on the site where the following conditions are met.

- (a) For connection to the indoor unit with an Auto descending panel, a place where people can check the Auto descending panel operation of the indoor unit while they are operating the remote controller (Refer to the indoor unit Instructions Book for how to operate Auto descending panel.)
- (b) A flat surface
- (c) A place where the remote controller can measure the accurate indoor temperature
 - Sensors to monitor indoor temperature are on the indoor unit and on the remote controller. When the room temperature is monitored with the sensor on the remote controller, the built-in sensor on the remote controller monitors the room temperature. When using the sensor on the indoor unit, follow the instructions below.
 - To monitor the accurate indoor temperature, install the remote controller away from direct sunlight, heat sources, and the supply air outlet of the air conditioner.
 - Install the remote controller in a location that allows the sensor to measure the representative room temperature.
 - Install the remote controller where no wires are routed around the temperature sensor on the controller. (If wires are routed, the sensor cannot measure accurate indoor temperature.)

Important

■ Discrepancy between the indoor temperature measured at the wall and the actual indoor temperature may occur.

If the following conditions are met, the use of the temperature sensor on the indoor unit is recommended.

- Supply air does not reach to the wall easily where the remote controller is installed due to improper airflow distribution.
- There is a great discrepancy between the wall temperature and the actual indoor temperature.
- The back side of the wall is directly exposed to the outside air.

Note: When temperature changes rapidly, the temperature may not be detected accurately.

Do not install the controller in a place where the difference between the remote controller surface temperature and the actual room temperature will be great. If the temperature difference is too high, room temperature may not be adequately controlled.

To reduce the risk of malfunctions, do not install the controller in a place where water or oil may come into contact with the controller, or in a condensing or corrosive environments.

To avoid deformation and malfunction, do not install the remote controller in direct sunlight or where the ambient temperature may exceed 40°C (104°F) or drop below 0°C (32°F).

To reduce the risk of malfunctions and damage to the controller, avoid installing the remote controller on an electrically conductive surface, such as an unpainted metal sheet.

Refer to either of the following manuals for temperature sensor setting: indoor unit Installation Manual for CITY MULTI; this manual for Mr. SLIM.

(2) Installation space

Leave a space around the remote controller as shown in the figure shown below, regardless of whether the controller is installed in the switch box or directly on the wall. Removing the remote controller will not be easy with insufficient space.

Also, leave an operating space in front of the remote controller.

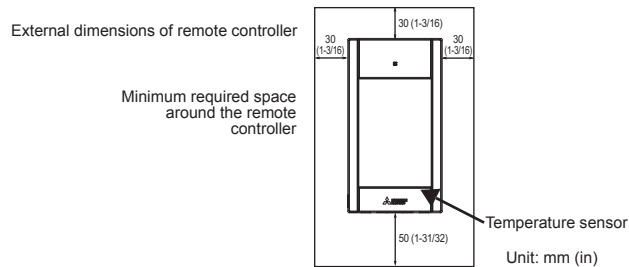

(3) Installation work

Controller can be installed either in the switch box or directly on the wall. Perform the installation properly according to the installation method.

① Drill a hole in the wall.

■ Installation using a switch box

- Drill a hole in the wall, and install the switch box on the wall.
- Connect the switch box to the conduit tube.

■ Direct wall installation

- Drill a hole in the wall, and thread the cable through it.

② Seal the cable access hole with putty.

■ Installation using a switch box

- Seal the remote controller cable access hole at the connection of switch box and conduit tube with putty.

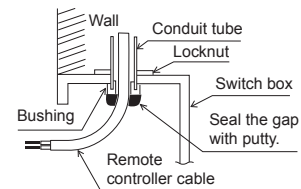

To reduce the risk of electric shock, malfunctions, or fire, seal the gap between the cables and cable access holes with putty.

③ Prepare the bottom case of the remote controller.

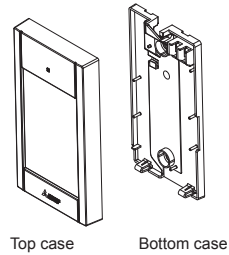

④ Connect the remote controller cable to the terminal block on the bottom case.

Peel off the remote controller cable sheath as shown below to connect to the terminal block properly. Secure the remote controller cable so that the peeled part of the cable will fit into the case.

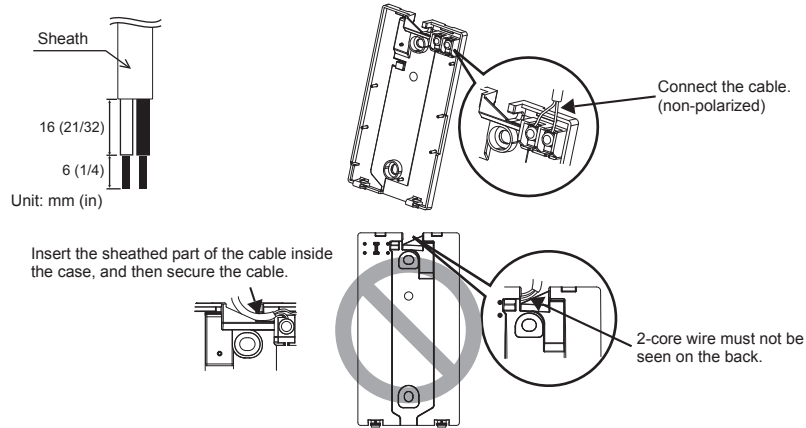

■ Direct wall installation

- Seal the hole through which the cable is threaded with putty.

To reduce the risk of electric shock, shorting, or malfunctions, keep wire pieces and sheath shavings out of the terminal block.

Important

Do not use solderless terminals to connect cables to the terminal block. Solderless terminals may come in contact with the circuit board and cause malfunctions or damage the controller cover.

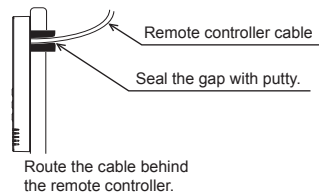

GB

⑤ **Install the bottom case.**

Be sure to secure two places of the bottom case.

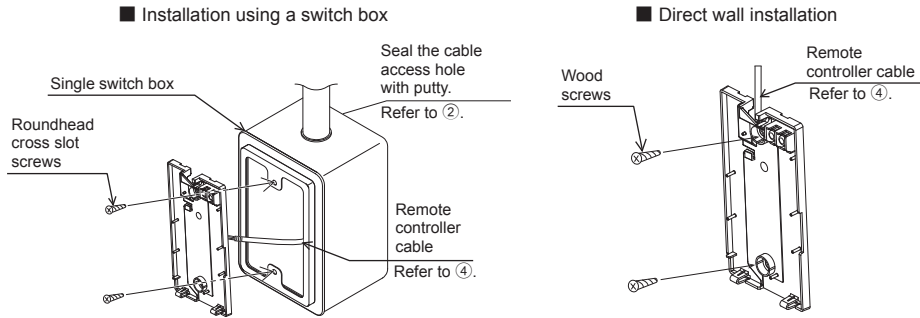

Important

To avoid deformation and damage to the bottom case, do not overtighten the screws.

To avoid damage to the bottom case, do not make holes on it.

⑥ **Cut out the cable access hole.**

- Direct wall installation (when running the cable along the wall)
 - Cut out the thin-wall part on the cover (the shaded area in the right figure) with a nipper.
 - Thread the cable from the groove behind the bottom case through this access hole.

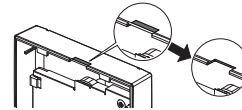

Notice

To prevent damage to the circuit board, remove the front cover from the top case before cutting out a cable access hole.

Note that accidentally touching the circuit board may damage the circuit board when cutting out a cable access hole.

⑦ **Connect the connector to the top case.**

Connect the connector on the bottom case to the socket on the top case.

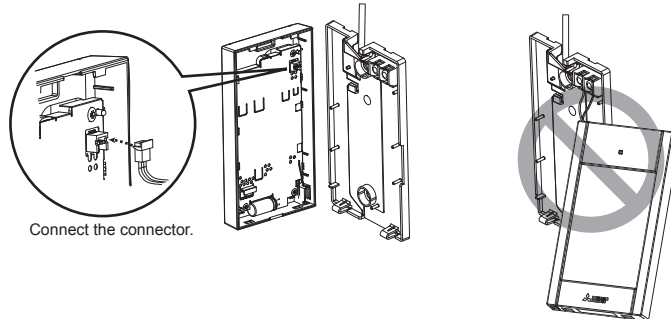

Important

To prevent malfunctions, do not remove the protective sheet or the circuit board from the top case.

To prevent cable breakage and malfunctions, do not hang the top controller casing hang by the cable as shown in the figure above.

⑧ **Insert the wires into the clamp.**

Important

Hold the wires in place with the clamp to prevent undue force from being applied to the terminal block and causing cable breakage.

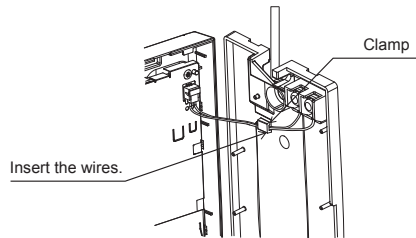

⑨ **Install the top case on the bottom case.**

Two mounting tabs are at the top of the top case.

Hook those two tabs onto the bottom case, and click the top case into place. Check that the case is securely installed and not lifted.

GB

Important

When attaching the top casing to the bottom casing, push it until it they click into place. If they are not properly locked into place, they may fall, causing personal injury, controller damage, or malfunctions.

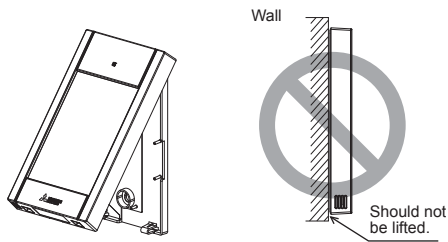

■ **Direct wall installation (when running the cable along the wall)**

- Thread the cable through the access hole at the top of the remote controller.
- Seal the cut-out part of the cover with putty.
- Use a cable cover.

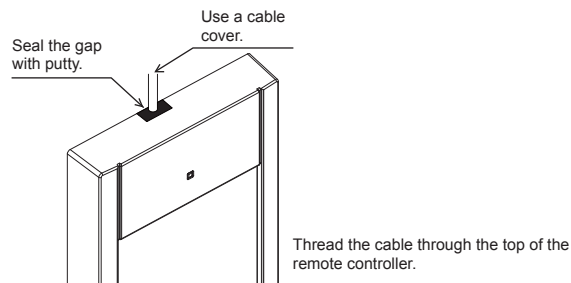

- **Uninstalling the top case**

- ① Uninstalling the top case

Insert a flat-tip screwdriver with a blade width of 3-5 mm (1/8-7/32 inch) into the latches at the bottom of the remote controller and lift the latches. Then, pull up the top case.

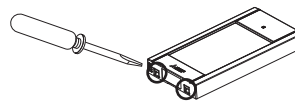

GB

■ **At the time of factory shipment, protective sheet is on the operation interface of the front cover. Peel off the protective sheet on the operation interface prior to use.**

Important

To prevent damage to the controller casing, do not force the flat-tip screwdriver to turn with its tip inserted in the slot.

Do not insert the flat-tip screwdriver too far. Doing so will damage the circuit board.

To prevent damage to the controller casing, use a flat-head screwdriver with a blade width of 3-5 mm (1/8-7/32 inch).

7 Remote controller button functions

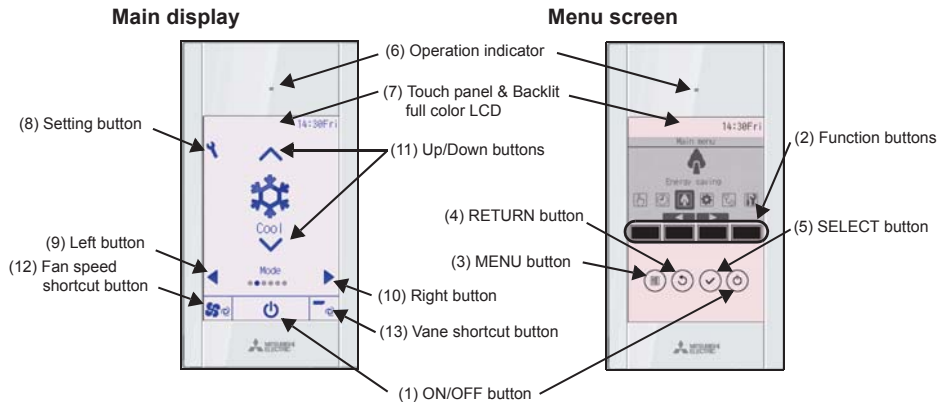

(1) ON/OFF button

Use to turn ON/OFF the indoor unit.

(2) Function buttons

Use to select the operation mode or to set the temperature and fan speed on the Main display. Use to select items on other screens.

(3) MENU button

Use to bring up the Main menu.

(4) RETURN button

Use to return to the previous screen.

(5) SELECT button

Use to jump to the setting screen or to save the settings.

(6) Operation indicator

Stays lit during normal operation. Blinks during startup and when an error occurs.

(7) Touch panel & Backlit full color LCD

Dot display. When the backlight is off, pressing any area turns the backlight on and it will stay lit for a certain period of time depending on the screen. Performing any button operation keeps the backlight on.

(8) Setting button

Use to bring up the Main menu. When the menu operation is locked, an administrator password is required.

(9) Left button

Use to switch the setting items in the following order: louver, ventilation, vane, fan speed, operation mode, and preset temperature.

(10) Right button

Use to switch the setting items in the following order: preset temperature, operation mode, fan speed, vane, ventilation, and louver.

(11) Up/Down buttons

Use to change the contents of the setting selected in (9) and (10) above.

(12) Fan speed shortcut button

Use to directly access the fan speed settings screen.

(13) Vane shortcut button

Use to directly access the vane settings screen.

Pressing the Setting button will bring up the Main menu as shown below.

Operation menu *1
 Timer menu *1
 Energy saving menu *1
 Initial setting menu *2*3
 Maintenance menu *1
 Service menu *2*3

*1 Refer to the Instructions Book in the CD-ROM for details.

*2 Explained in this manual.

*3 If no buttons are pressed for 10 minutes on the initial setting screens, or 2 hours on the service screens (10 minutes on some screens), the screen will automatically return to the Main display. Any settings that have not been saved will be lost.

The available items on the menu depend on the connected indoor unit model. For items not described in the manuals that are enclosed with the MA Touch Remote Controller, refer to the manuals that came with the air conditioning units.

Note: When the backlight is off, pressing any area turns the backlight on and does not perform its function.

GB

Button operations on the Main menu

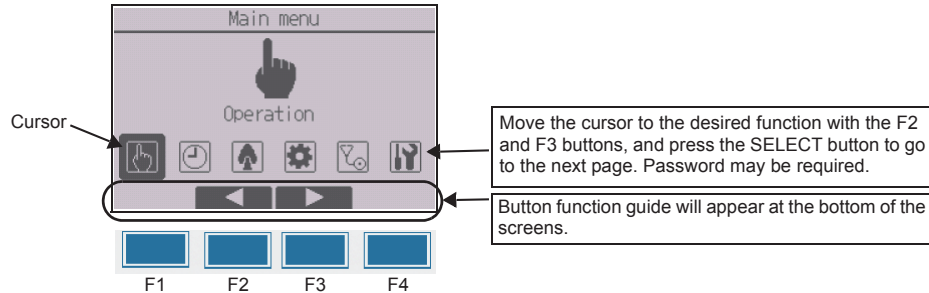

GB

8 Turning on the power

Make sure that the MA remote controller is properly installed according to the instructions in the Installation Manual and that the indoor and outdoor unit installation has been completed before turning on the power.

- (1) When the power is turned on, the following screen will appear.

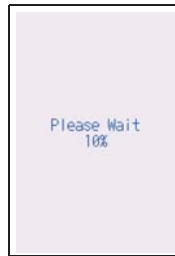

Normal start up (indicating the percentage of process completion)

Note: When the power is on for the first time, the Language selection screen will be displayed. Refer to section 10 (4) under "Display setting menu". Select a desired language. The system will not start-up without language selection.

- (2) Main display

After the successful startup, the Status display will appear. While the Status display is displayed, pressing any area switches the screen to the Main display. The Main display can be displayed in two different modes: "Full" and "Basic." Refer to section 10 "Initial settings" for how to select the display mode. (The factory setting is "Full.")



Main display in the Full mode (while the unit is not in operation)



Main display in the Full mode (while the unit is in operation)

Note: Refer to the Instruction Book for the icons on the display.

9 Test run

Note: Maintenance password is required.

- (1) Read the section about Test run in the indoor unit Installation Manual before performing a test run.
- (2) At the Main display, press the Setting button and select Service>Test run>Test run.
- (3) Press the ON/OFF button to cancel the test run if necessary.
- (4) Refer to the indoor unit Installation Manual for the detailed information about test run and for how to handle the errors that occur during a test run.

Note: Refer to section 11 "Service menu" for information about the maintenance password.

GB

10 Initial settings (Remote controller settings)

Note: Administrator password is required.

From the Main display, select Main menu>Initial setting, and make the remote controller settings on the screen that appears.

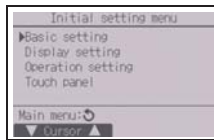

Basic setting menu

- Clock
- Daylight saving time
- Administrator password

Display setting menu

- Main display
- Remote controller display details setting
- Brightness
- Language selection
- Design

Operation setting menu

- Auto mode

Touch panel menu

(Refer to the Instruction Book.)

Note: The initial administrator password is "0000." Refer to section (3) "Administrator password setting" for how to change the password.

Basic setting menu

- (1) Clock setting

[Button operation]

- ① Move the cursor with the F1 or F2 button to the desired item.
- ② Change the date and time with the F3 or F4 button, and press the SELECT button to save the change. The change will be reflected on the clock display on the Status display and the Main display.

Note: Clock setting is necessary for time display, weekly timer, timer setting and error history. Make sure to perform clock setting when the unit is used for the first time or has not used for a long time.

Note: If a given system has no system controllers, the clock time will not automatically be corrected. In this case, periodically correct the clock time.

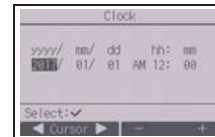

(2) Daylight saving time

The start/end time for daylight saving time can be set. The daylight saving time function will be activated based on the setting contents.

- If a given system has a system controller, disable this setting to keep the correct time.
- At the beginning and the end of daylight saving time, the timer may go into action twice or not at all.
- This function will not work unless the clock has been set.



[Button operation]

- ① The daylight saving time function can be activated/deactivated or the start/end times can be set by using the F1 through F4 buttons.
 - DST
Select "Yes" to activate the daylight saving time, or select "No" to deactivate.
 - Date(Start)
Set the start day of the week, week number, and month for daylight saving time.
 - Start time
Set the start time for daylight saving time.
 - Forward to
Set the time when the clock is to be set forward to at the start time above.
 - Date(End) (2nd page)
Set the end day of the week, week number, and month for daylight saving time.
 - End time (2nd page)
Set the end time for daylight saving time.
 - Backward to (2nd page)
Set the time when the clock is to be set backward to at the end time above.
- ② Press the SELECT button to save the setting.
 - * If "5th" is selected for the week number and the 5th week does not exist in the selected month of the year, the setting is considered to be "4th."

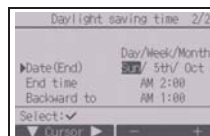

(3) Administrator password setting

[Button operation]

- ① A window to enter a new password will appear. Enter a new password, and press the SELECT button.
- ② Press the F4 button (OK) on the password change confirmation screen to save the change. Press the F3 button (Cancel) to cancel the change.

Note: The initial administrator password is "0000." Change the default password as necessary to prevent unauthorized access. Have the password available for those who need it.

Note: If you forget your administrator password, you can initialize the password to the default password "0000" by pressing and holding the F1 button for ten seconds on the administrator password setting screen.

Note: The administrator password is required to make the settings for the following items.

- Timer setting · Weekly timer setting · Energy-save setting
- Outdoor unit silent mode setting · Restriction setting
- Night setback setting · Initial setting

Refer to the Instruction Book that came with the remote controller for the detailed information about how to make the settings for these items.

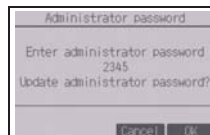
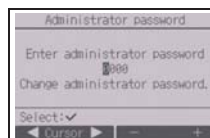

Display setting menu

(1) Main display setting

[Button operation]

- ① Move the cursor to "Full/Basic," and use the F3 or F4 button to select the display mode "Full" or "Basic." (The factory setting is "Full.")
- ② Move the cursor to "Icon explan.," and use the F3 or F4 button to select the display mode "Yes" or "No." (The factory setting is "Yes.")

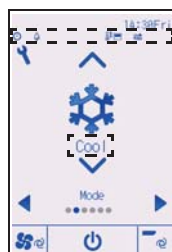

Example: Full mode
(Icon explanation enabled)

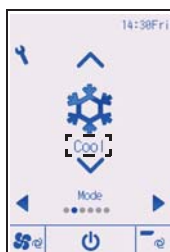

Example: Basic mode
(Icon explanation enabled)



Example: Full mode
(Icon explanation disabled)



Example: Basic mode
(Icon explanation disabled)

Note: This setting is only for the Main display. In the Basic mode, icons that indicate control status on timer and schedule settings will not appear on the display. When "No" is selected, the explanation of the setting contents on the Main display will not appear.

(2) Remote controller display details setting

Make the settings for the remote-controller-related items as necessary.
Press the SELECT button to save the changes.



[1] Clock display

[Button operation]

- ① Select "Clock" from the display details setting screen, and press the F4 button (Change) to bring up the clock display setting screen.
- ② Use the F1 through F4 buttons to select "Yes" (display) or "No" (non-display) and its format for the Status display and the Main display.
- ③ Save the settings with the SELECT button. (The factory settings are "Yes" (display) and "24 h" format.)

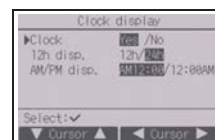

Clock display: Yes (Time is displayed on the Status display and the Main display.)
 No (Time is not displayed on the Status display and the Main display.)
 Display format: 24-hour format
 12-hour format
 AM/PM display (Effective when the display format is 12-hour): AM/PM before the time
 AM/PM after the time

Note: Time display format will also be reflected on the timer and schedule setting display. The time is displayed as shown below.
 12-hour format: AM12:00 ~ AM1:00 ~ PM12:00 ~ PM1:00 ~ PM11:59
 24-hour format: 0:00 ~ 1:00 ~ 12:00 ~ 13:00 ~ 23:59

GB

[2] Temperature unit setting

[Button operation]

Move the cursor to "Temperature" from the display details setting screen, and select the desired temperature unit with the F3 or F4 button. (The factory setting is Centigrade (°C).)

- °C: Temperature is displayed in Centigrade. Temperature is displayed in 0.5- or 1-degree increments, depending on the model of indoor units.
- °F: Temperature is displayed in Fahrenheit.
- 1 °C: Temperature is displayed in Centigrade in 1-degree increments.

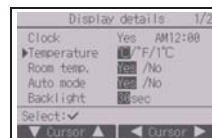

[3] Room temperature display

[Button operation]

Move the cursor to "Room temp." on the display details setting screen, and select the desired setting with the F3 or F4 button.

(The factory setting is "Yes".)

- Yes: Room temperature appears on the Main display.
- No: Room temperature does not appear on the Main display.

Note: Even when "Yes" is set, the room temperature is not displayed on the Main display in the "Basic" mode.

[4] Auto (single set point) mode display setting

[Button operation]

Move the cursor to "Auto mode" from the display details setting screen, and select the desired mode with the F3 or F4 button. (The factory setting is "Yes".)

- Yes: "Auto Cool" or "Auto Heat" is displayed during operation in the Auto (single set point) mode.
- No: Only "Auto" is displayed during operation in the Auto (single set point) mode.

[5] Backlight

The backlight lighting-up time can be set.

[Button operation]

Move the cursor to "Backlight" from the display details setting screen, and select the desired time (5/10/20/30/60 seconds) with the F4 button. (The factory setting is "30" seconds.)

Note: This setting is effective on the Status display and the Main display.

[6] LED lighting

The LED lighting can be set to either "Yes" (On) or "No" (Off). (The factory setting is "Yes".)

When "No" is selected, the LED will not light up even during the normal operation.

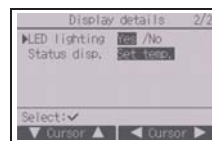

[7] Status display

Make the settings for the temperature to be displayed on the Status display.

[Button operation]

Move the cursor to “Status disp.” from the display details setting screen, and select the desired setting with the F4 button.

Each pressing the F4 button will toggle through the following options: Set temp., Room temp., and Hide.

(3) Brightness

[Button operation]

Select the desired brightness for the remote controller LCD with the F1 and F2 buttons.

The ON/OFF of the Stay lit mode can be switched with the F4 button. When “ON” is selected, the backlight will remain lit dimly even after the specified time has elapsed.

Note: Adjust the brightness to improve viewing in different lighting conditions or installation locations. This setting can not improve viewing from all directions.



GB

(4) Language selection

[Button operation]

Move the cursor to the language you desire with the F1 through F4 buttons.

Press the SELECT button to save the setting.



(5) Design setting

The screen design can be set.

[Button operation]

Select the color option with the F4 button.

- Color: The display color can be selected.
- White: Monochrome display (white basis)
- Black: Monochrome display (black basis)

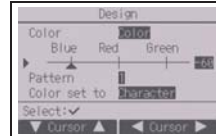

When “White” or “Black” is selected, press the SELECT button. When “Color” is selected, select the following item with the F1 or F2 button, and set the desired display color for each item.

- Color shade: Set the color shade with the F3 or F4 button. (The settable range is -90 to 89.)
- Pattern: Set the color with the F4 button.
- Color set to: Select “Character” or “BG” (Background) as a target to which the color is applied with the F4 button.

* At factory shipment, these items are set as follows.

	Color option	Color shade	Pattern	Color set to
CT01MAA(R)-S, SB	Color	-70	1	Character
CT01MAA(R)-PB	Color	-90	2	Character

Operation setting menu

(1) Auto mode setting

[Button operation]

Whether or not to use the Auto (single set point) or Auto (dual set points) mode can be selected by using the F3 or F4 button. This setting is valid only when indoor units with the Auto mode function are connected.

(The factory setting is "Yes".)

Press the SELECT button to save the changes made.

- Yes: The Auto mode can be selected in the operation mode setting.
- No: The Auto mode cannot be selected in the operation mode setting.

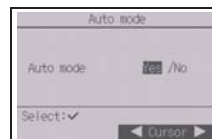

GB

11 Service menu

Note: Maintenance password is required.

At the Main display, press the Setting button and select "Service" to make the maintenance settings.

When the Service menu is selected, a window will appear asking for the password.

To enter the current maintenance password (4 numerical digits), move the cursor to the digit you want to change with the F1 or F2 button, and set each number (0 through 9) with the F3 or F4 button. Then, press the SELECT button.

Note: The initial maintenance password is "9999." Change the default password as necessary to prevent unauthorized access. Have the password available for those who need it.

Note: If you forget your maintenance password, you can initialize the password to the default password "9999" by pressing and holding the F1 button for ten seconds on the maintenance password setting screen.

Note: Air conditioning units may need to be stopped to make certain settings. There may be some settings that cannot be made when the system is centrally controlled.

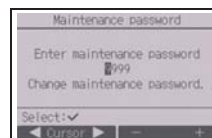

(1) Test run (CITY MULTI and Mr. SLIM)

Select "Test run" from the Service menu to bring up the Test run menu.

- Test run: Select this option to perform a test run.
- Drain pump test run: Select this option to perform a test run on the drain pump on the indoor unit.

Applicable only to the type of indoor units that support the test run function.

Note: Refer to the indoor unit Installation Manual for the detailed information about test run.

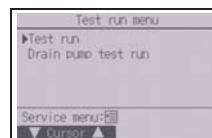

(2) Input maintenance information (CITY MULTI and Mr. SLIM)

Select "Input maintenance info." from the Service menu to bring up the Maintenance information screen. Refer to the indoor unit Installation Manual for how to make the settings.

Note: The following settings can be made from the Maintenance information screen.

- Registering model names and serial numbers
Enter the model names and serial numbers of outdoor and indoor units. The information entered will appear on the Error information screen. Model names can have up to 18 characters, and the serial numbers can have up to 8 characters.
- Registering dealer information
Enter phone number of a dealer. The entered information will appear on the Error information screen. Phone number can have up to 13 characters.
- Initializing maintenance information
Select the desired item to initialize the model name, serial number, and dealer information settings.

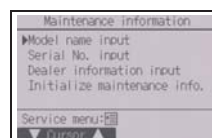

GB

(3) Function setting (CITY MULTI)

Make the settings for the indoor unit functions via the remote controller as necessary.

Select "Function setting" from the Settings menu to bring up the Function setting screen.

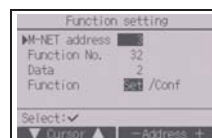

[Button operation]

① The Function setting screen will appear.

Press the F1 or F2 button to move the cursor to one of the following: M-NET address, function setting number, or setting value. Then, press the F3 or F4 button to change the settings to the desired settings.

② Once the settings have been completed, press the SELECT button.

A screen will appear that indicates that the settings information is being sent.

To check the current settings of a given unit, enter the setting for its M-NET address and function setting number, select Conf for the Function, and press the SELECT button.

A screen will appear that indicates that the settings are being searched for. When the search is done, the current settings will appear.

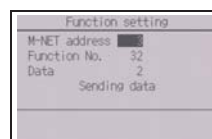

③ When the settings information has been sent, a screen will appear that indicates its completion.

To make additional settings, press the RETURN button to return to the screen shown in Step ② above. Set the function numbers for other indoor units by following the same steps.

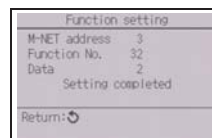

Note:

- Refer to the indoor unit Installation Manual for information about the factory settings of indoor units, function setting numbers, and setting values.
- Be sure to write down the settings for all functions if any of the initial settings has been changed after the completion of installation work.

(4) Function setting (Mr. SLIM)

Make the settings for the indoor unit functions via the remote controller as necessary.

Select "Function setting" from the Settings menu to bring up the Function setting screen.

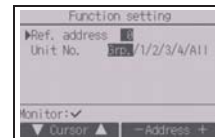

GB

[Button operation]

- ① Set the indoor unit refrigerant addresses and unit numbers with the F1 through F4 buttons, and then press the SELECT button to confirm the current setting.
- ② When data collection from the indoor units is completed, the current settings appears highlighted. Non-highlighted items indicate that no function settings are made. Screen appearance varies depending on the "Unit No." setting.

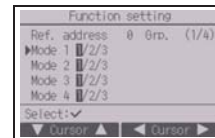

Common items

- ③ Use the F1 or F2 button to move the cursor to select the mode number, and change the setting number with the F3 or F4 button.



Individual items
(Unit No. 1 through 4)

- ④ When the settings are completed, press the SELECT button to send the setting data from the remote controller to the indoor units.
- ⑤ When the transmission is successfully completed, the screen will return to the Function setting screen.

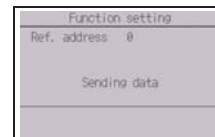

Note:

- Make the function settings shown in Table 1 on Mr. SLIM units as necessary.
- Refer to the Instructions Book when it is necessary to set the settings for CITY MULTI units.
- **Table 1 summarizes the setting options for each mode number. Refer to the indoor unit Installation Manual for the detailed information about initial settings, mode numbers, and setting numbers for the indoor units.**
- Be sure to write down the settings for all functions if any of the initial settings has been changed after the completion of installation work.

Table1. Function setting options

Mode No.	Mode	Settings	Setting No.	Unit numbers
01	Automatic recovery after power failure	Disable	1	Set "Grp." for the Unit number. These settings apply to all the connected indoor units.
		Enable (Four minutes of standby time is required after the restoration of power.)	2	
02	Thermistor selection (indoor temperature detection)	Average temperature reading of the indoor units in operation	1	
		Thermistor on the indoor unit to which the remote controller is connected (fixed)	2	
		Built-in sensor on the remote controller	3	
03	LOSSNAY connection	Not connected	1	
		Connected (without outdoor air intake by the indoor units)	2	
		Connected (with outdoor air intake by the indoor units)	3	
04	Power voltage	240 V	1	
		220 V, 230 V	2	
05	Auto mode	Enable (Automatically the unit achieves effective energy saving operation.)	1	
		Disable	2	
07	Filter sign	100 hours	1	Set "1, 2, 3, 4, or All" for the Unit number. These settings apply to each indoor unit. *If "1, 2, 3, or 4" is set for the Unit number, the settings apply only to the specified indoor unit regardless of the number of connected indoor units (one through four units). *If "All" is set for the Unit number, the settings apply to all the connected indoor units regardless of the number of connected indoor units (one through four units).
		2500 hours	2	
		Not displayed	3	
08	Fan speed	Silent mode (or standard)	1	
		Standard (or High ceiling 1)	2	
		High ceiling (or High ceiling 2)	3	
09	Outlet	4 directional	1	
		3 directional	2	
		2 directional	3	
10	Optional parts (High-efficiency filter)	No	1	
		Yes	2	
11	Vane	No vanes (or the vane setting No.3 is effective.)	1	
		Equipped with vanes (The vane setting No.1 is effective.)	2	
		Equipped with vanes (The vane setting No.2 is effective.)	3	

(5) LOSSNAY setting (CITY MULTI only)

This setting is required only when the operation of CITY MULTI units is interlocked with LOSSNAY units. This setting is not available for the Mr. SLIM units. Interlock settings can be made for the indoor unit to which the remote controller is connected. (They can also be confirmed or deleted.)

Note:

- Use the centralized controller to make the settings if it is connected.
- To interlock the operation of the indoor units with the LOSSNAY units, be sure to interlock the addresses of ALL indoor units in the group and that of the LOSSNAY unit.

[Button operation]

- ① When "Lossnay" on the Settings menu is selected, the remote controller will automatically begin searching for the registered LOSSNAY addresses of the currently connected indoor unit.

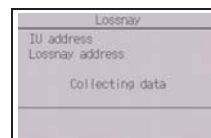

- ② When the search is completed, the smallest address of the indoor units that are connected to the remote controller and the address of the interlocked LOSSNAY unit will appear. "--" will appear if no LOSSNAY unit is interlocked with the indoor units. If no settings need to be made, press the RETURN button to go back to the Settings menu.

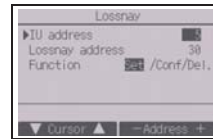

To make LOSSNAY interlock setting

- ③ Enter the addresses of the indoor unit and the LOSSNAY unit to be interlocked, with the F1 through F4 buttons, select "Set" in the "Function", and press the SELECT button to save the settings. "Sending data" will appear on the screen. If the setting is successfully completed, "Setting completed" will appear.

GB

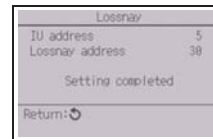
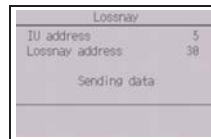

To search for the LOSSNAY address

- ④ Enter the address of the indoor unit to which the remote controller is connected, select "Conf" in the "Function", and press the SELECT button. "Collecting data" will appear on the screen. If the signal is received correctly, the indoor unit address and LOSSNAY address will appear. "--" will appear when no LOSSNAY unit is found. "Unit not exist" will appear if no indoor units that are correspond to the entered address are found.

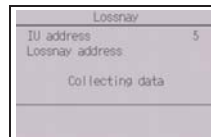

To delete the interlock setting

- ⑤ To delete the interlocked setting between LOSSNAY unit and the indoor units to which the remote controller is connected, enter the indoor unit address and LOSSNAY address with the F1 through F4 buttons, select "Del." in the "Function", and press the SELECT button. "Deleting" will appear. The screen will return to the search result screen if the deletion is successfully completed. "Unit not exist" will appear if no indoor units that are correspond to the entered address are found. If deletion fails, "Request rejected" will appear on the screen.

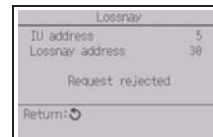
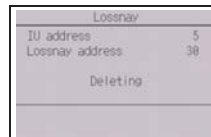

(6) Check

Select "Check" on the Service menu to bring up the Check menu screen.

The type of menu that appears depends on the type of indoor units that are connected (CITY MULTI or Mr. SLIM).

(When CITY MULTI is connected, only "Error history" will appear in the menu.)

<Mr. SLIM>

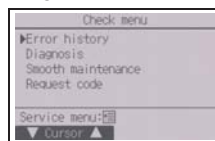

<CITY MULTI>

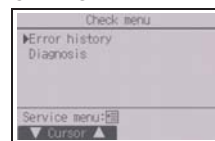

[Button operation]

① Error history

Select "Error history" from the Check menu, and press the SELECT button to view up to 16 error history records. Four records are shown per page, and the top record on the first page indicates the latest error record.

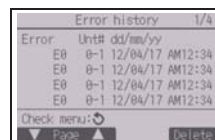

GB

[Deleting the error history]

To delete the error history, press the F4 button (Delete) on the screen that shows error history. A confirmation screen will appear asking if you want to delete the error history.

Press the F4 button (OK) to delete the error history.

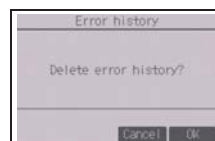

"Error history deleted" will appear on the screen. Press the RETURN button to go back to the Check menu screen.

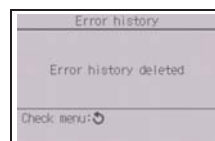

② Other options in the Check menu (Mr. SLIM only)

The following options are also available on the Mr. SLIM units in the Check menu.

- Smooth maintenance
- Request code

These options are available only on the Mr. SLIM units. Refer to the indoor unit Installation Manual for details.

(7) Diagnostic function

Error history of each unit can be checked via the remote controller.

[Button operation]

① Select "Self check" from the Diagnosis menu, and press the SELECT button to view the Self check screen.

<Mr. SLIM>

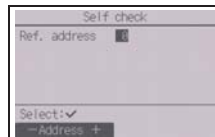

<CITY MULTI>

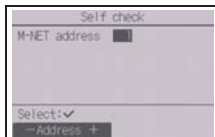

② With the F1 or F2 button, enter the refrigerant address (Mr. SLIM) or the M-NET address (CITY MULTI), and press the SELECT button.

③ Error code, unit number, attribute, and indoor unit demand signal ON/OFF status at the contact (CITY MULTI only) will appear. "-" will appear if no error history is available.

<Mr. SLIM>



<CITY MULTI>



When there is no error history

[Resetting the error history]

- Press the F4 button (Reset) on the screen that shows the error history. A confirmation screen will appear asking if you want to delete the error history.

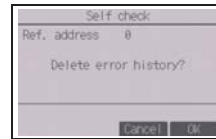

- Press the F4 button (OK) to delete the error history. If deletion fails, "Request rejected" will appear, and "Unit not exist" will appear if no indoor units that are correspond to the entered address are found.

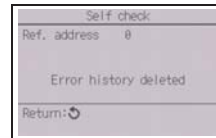

GB

(8) Changing the maintenance password

[Button operation]

- Select "Maintenance password" on the Others menu, and press the SELECT button to bring up the screen to enter a new password.
- Move the cursor to the digit you want to change with the F1 or F2 button, and set each digit to the desired number (0 through 9) with the F3 or F4 button.
- Press the SELECT button to save the new password.
- A confirmation screen will appear asking if you want to change the maintenance password. Press the F4 button (OK) to save the change. Press the F3 button (Cancel) to cancel the change.

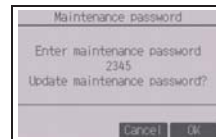
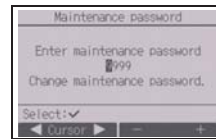

- "Changes saved" will appear when the password is updated.
- Press the MENU button to return to the Service menu or press the RETURN button to go back to the "Maintenance password" screen.

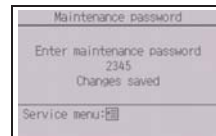

(9) Remote controller information

The following information of the remote controller in use can be checked.

- Model name
- Software version
- Serial number

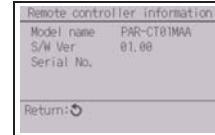

[Button operation]

- ① Select "Others" from the Service menu.
- ② Select "Remote controller information".

12 Remote controller check

When the remote controller does not work properly, use the remote controller checking function to troubleshoot the problem.

- ① Check the remote controller display and see if anything is displayed (including lines). Nothing will appear on the remote controller display if the correct voltage (8.5-12 VDC) is not supplied to the remote controller. If this is the case, check the remote controller wiring and indoor units.

[Button operation]

- ① Select "Remote controller check" from the Diagnosis menu, and press the SELECT button to start the remote controller check and see the check results. To cancel the remote controller check and exit the Remote controller check menu screen, press the MENU or the RETURN button. The remote controller will not reboot itself.

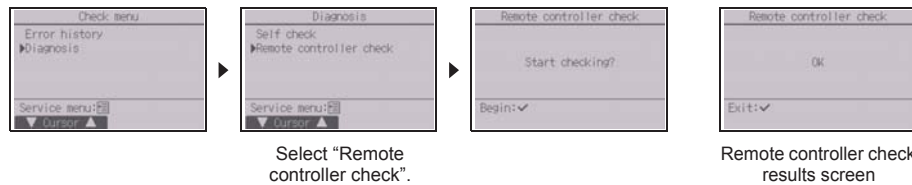

OK: No problems are found with the remote controller. Check other parts for problems.

E3, 6832: There is noise on the transmission line, or the indoor unit or another remote controller is faulty. Check the transmission line and the other remote controllers.

NG (ALL0, ALL1): Send-recv circuit fault. Remote controller needs replacing.

ERC: The number of data errors is the discrepancy between the number of bits in the data transmitted from the remote controller and that of the data that was actually transmitted over the transmission line. If data errors are found, check the transmission line for external noise interference.

- ② If the SELECT button is pressed after the remote controller check results are displayed, remote controller check will end, and the remote controller will automatically reboot itself.